

DUNE

DUNE seating system offers a variety of configurations, sizes and material options. It's designed to create informal spaces that promote and enhance creativity. A flexible modular design that can be used to create spaces that are unique to organizations and individuals. DUNE was designed to create spaces where people feel an emotional connection.

Multiple shapes, forms, patterns and textures are used to promote variation over uniformity.

DUNE is comprised of three key seating elements: single, double and triple. All of these elements can be linked and secured together easily. Single and double side backrests offer flexible and modern design can be used to create spaces that are unique to organizations and the people who work there.



TECHNICAL FEATURES

Type	Modular elements for waiting areas.
Back units	Fully cold-cure injected polyurethane foams of high density 60+/-/cbm. Low backrest, high backrest and double seat high backrest
Seat units	Fully cold-cure injected polyurethane foams of high density 60+/-/cbm. .Available as single seat and single seat for backrest use.
Base	Steel base and feet in square section epoxy powder coating Black RAL 9005 matt with floor protective black PVC glides. Available in three different dimensions as single, double and triple modules.
Lining	Polyester microfiber bonded onto a polyamide velveteen backing.
Side table	In laminate black color.
Upholstery	Fabrics or leather upholstery. COM/COL upon approval.

OVERVIEW & DIMENSIONS

BASE FRAMES

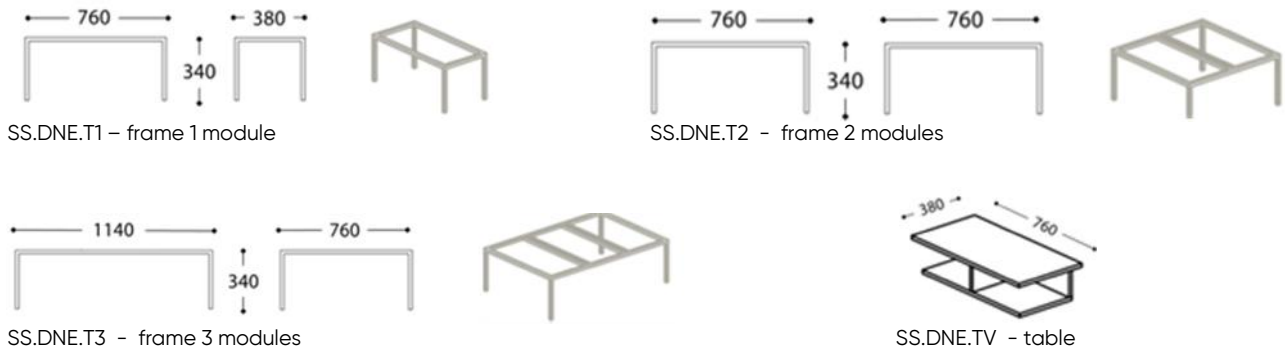

SEATING ELEMENTS



BACK ELEMENTS

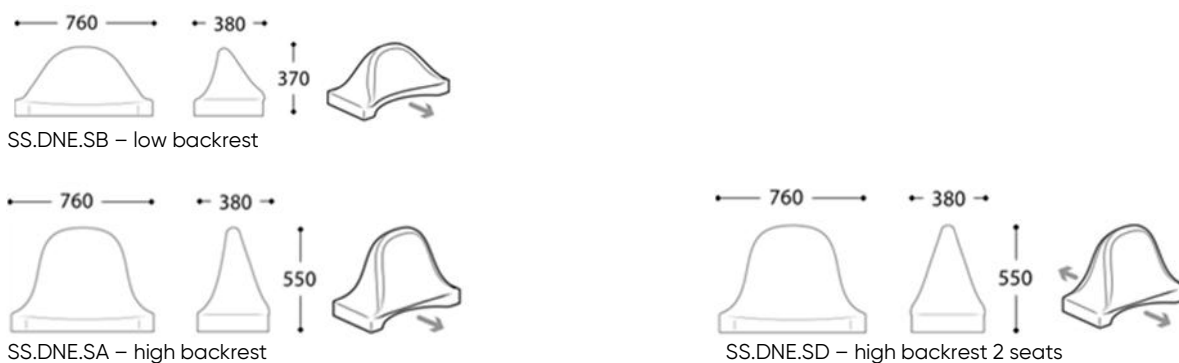

COLORS & MATERIALS

Square tubular Steel frame finished with epoxy powder coating RAL 9005 matt. MAT_1 can be upholstered in a wide range of contract fabrics and eco-leathers from Spaceform's standard upholstery collection.

Customer's Own material – fabrics and leathers – are applicable subject to Spaceform approval after testing the submitted samples.

BASE FINISHES

M-NI



Nero 9005
Black 9005

GENUINE LEATHER UPHOLSTERY

L670



Bianco/White

L681

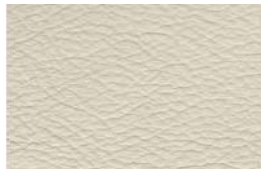

Crema/Cream

L691



Cappuccino

L680



Beige

L615

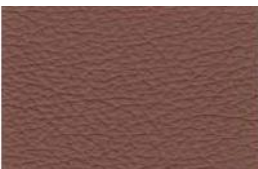

Tobacco

L622

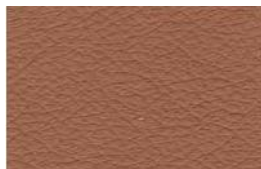

Naturale

L614

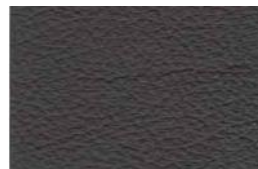

Brown

L644

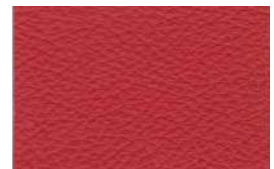

Rosso/Red

L629

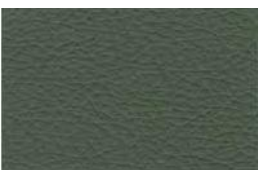

Verde/Green

L663



Navy Blue

L630

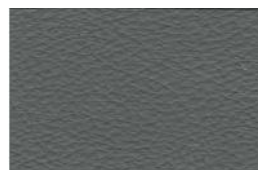

Cenere/Ash

L610

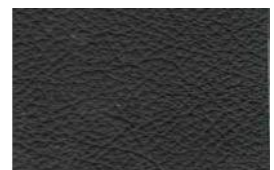

Nero/black

Color images above are for reference only. Please verify actual color samples.

INSPIRATIONS

