

SS | 012

System of sofas with a strong embracing identity. Armchairs, sofas in different sizes designed to offer as an executive seating range for high quality receptions, lounge areas and private offices. Its style is emphasized by the all-around tubular aluminium frame and the elegant and stylish aluminium legs. The balanced proportions are assuring a comfortable and long lasting sitting.

The polished chromed details of the frame embellish the aesthetic of the range. The wide selection of finishing and colours, leather included, can have the product placed in any setting with sobriety. Although its generous dimensions, the system can be used equally in any small or big area due to its compacted cubical construction shape.



TECHNICAL FEATURES

Type	Sofa system of individual elements.
Back Frame	Traditional construction made of reinforced double-panelled fir-wood rubber-coated with layers of variable polyurethane densities.
Seat Frame	Reinforced multilayer poplar wood equipped with interlaced high resistance elastic belts of 80mm.
Padding	Padding for seat and backrest made of polyurethane foams covered with acrylic fibre layers.
Lining	Polyester microfiber bonded onto a polyamide velveteen backing.
Seat cushions	Made of high density polyurethane foam of 40kg/m ³ and acrylic fibre layer.
Back cushions	Made of polyurethane foam and acrylic fibre layers.
Armrests	All-in-one construction type with the horizontal frame.
Base	Tubular aluminium all-around frame with 4 legs, satin chromed or epoxy powder coated with floor protective black glides.
Upholstery	Fabrics or leather upholstery. COM/COL upon approval.

ENVIRONMENTAL PERFORMANCE

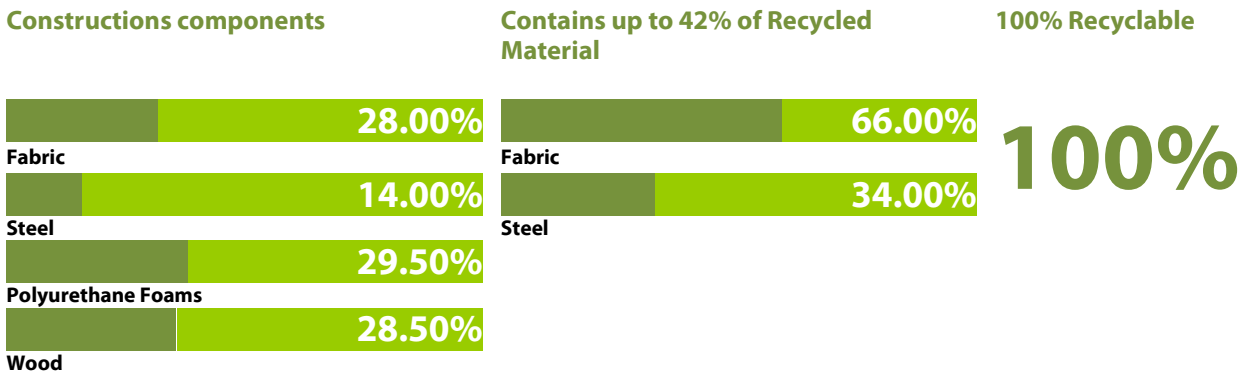

OVERVIEW & DIMENSIONS

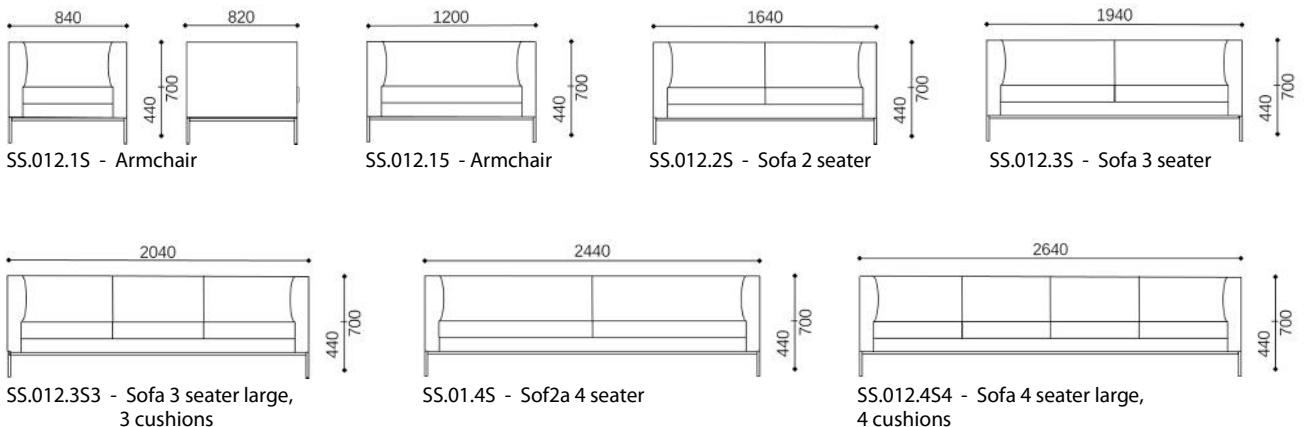

COLORS & MATERIALS

Tubular Cast Aluminum frame polished, satin or with epoxy powder coating.

SS012 can be upholstered in a wide range of contract fabrics and eco-leathers from Spaceform's standard upholstery collection.

Customer's Own material – fabrics and leathers – are applicable subject to Spaceform approval after testing the submitted samples.

BASE FINISHES

AL-P



Lucido Polished

AL-B



Nero 9005 Black 9005

GENUINE LEATHER UPHOLSTERY

L670



Bianco/White

L681

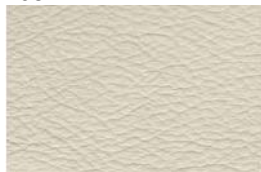

Crema/Cream

L691



Cappuccino

L680



Beige

L615

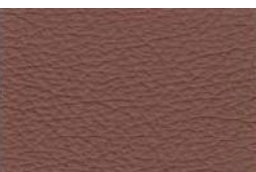

Tobacco

L622

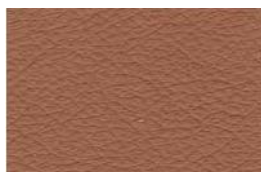

Naturale

L614

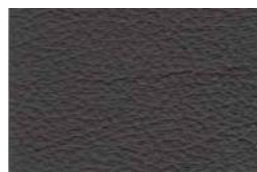

Brown

L644



Rosso/Red

L629

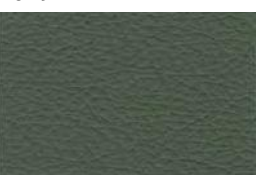

Verde/Green

L663

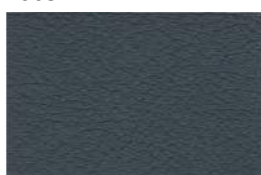

Navy Blue

L630

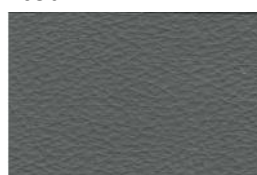

Cenere/Ash

L610

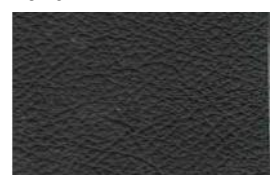

Nero/>black

Color images above are for reference only. Please verify actual color samples.

INSPIRATIONS

