



CATALOGUE
2017-2018



... GIVE US **IDEAS**
WE MAKE THEM **HAPPEN.**

INDEX

About the company	p.05
Soft seating	p.10
Hammer	p.11
Pallet	p.19
SS007	p.26
SS010	p.33
SS012	p.37
SS016	p.45
SS022	p.51
Breakout&Chair	p.58
8Cube	p.59
SS031, SS032, SS036	p.63
SS033	p.67
SS034	p.71
SS035	p.75
SS037	p.79
SS038	p.83
SS040	p.87
SS042	p.93
Office	p.98
PAK Chair	p.99
MIR Chair	p.107
MIR3 Chair	p.113

Overview&Dimensions	p.118
Hammer	p.119
Pallet	p.120
SS007	p.121
SS010	p.122
SS012	p.123
SS016	p.124
SS022	p.125
8Cube	p.126
SS031, SS032, SS036	p.127
SS033	p.128
SS034	p.129
SS035	p.130
SS037	p.131
SS038	p.132
SS040	p.133
SS042	p.134
PAK Chair	p.135
MIR Chair	p.136
MIR3 Chair	p.137

ABOUT THE COMPANY

ABOUT SPACEFORM

DESIGN, COMFORT and FUNZIONALITY

SPACEFORM is a dynamic and modern company that lays its foundations in the recent decade. Today we are a local owned family company operating with an international eye in the manufacturing of seating products for offices, communities and contract. From the very beginning the company has implemented an approach which combines technical expertise, flexibility, research and spirit of adventure: all focused on one action: CARE of DETAILS.

We create innovative, functional and high-quality furniture. High-quality products with a distinctive design that is immediately recognizable. Our commitment is to create comfortable and functional environments, designed to make spaces a more practical and pleasant environments, tailor made on customer needs. We interact closely with a clientele of high international standards and designers who all share the passion for quality and creativity that characterizes SPACEFORM. They give us their unique opinion on the current trends and the way we live now into the urban audience so to accomodate all aspects of modern lifestyles. We believe mandatory to offer a level of products and services of the highest professionalism, everywhere in the world in every phase of the project progress. Every of our product is functional. Every of our product development is subject to change in its attempt to get better. Every of our new product is a new challenge and we look into it with the same enthusiasm. Every of our product is as beautiful as useful.

VISION

SPACEFORM shall be a leading provider of innovative, functional and high-quality furniture for hospitality and public spaces being based on consumer oriented visions and strategies where the client is the focus to offer the best product quality.

MAKING LIFE BETTER WHILE SITTING

We believe in making life better when sitting, at work or while waiting. At Spaceform we do more than just selling furniture. With products and services to match your needs, we deliver inspiring and exciting solutions to help your body and mind.

OPERATIONS

By using innovative constructions, new and eco-friendly materials SPACEFORM operates to solve problems, to build «things», products, projects and services. Simply we operate within spaces to make them practical, pleasant and tailor made on customer needs.

DISCOVERING ON EVERY LEVEL

Step by step, we look at ways our products can provide solutions for a range of common demands on the workplace by having in mind that the real discovery does not consist in creating new products but in seeing them with new eyes.

OUR SUSTAINABILITY COMMITMENT

RENOVATE - RECYCLE – REDUCE - RAW MATERIALS - REFRESH AIR

We regularly monitor and review our performance to ensure we manufacture in the most sustainable and responsible manner. Making life better when sitting is about seeing the inner potential in everything . It is the start of a chain reaction. A chain reaction that rotates around our R5 environmental commitment developed to encourage us to create environments that generate health, well-being and productivity. We take responsibility for the entire chain. From Raw Material to manufacturing processes, from Air impacts to refurbishment. . We yearn for continually Reducing our energy consumption and waste of production. We aim to provide quality solutions characterized by pure and smart resources, craftsmanship, cooperation, Recycling and ergonomics. We offer customers the option of having old products professionally Renewed or disposed of in a sustainable and environmentally friendly manner to minimize waste consumption. Choosing a healthier, happier and more productive products it also means a more successful and more sustainable business.

Our R5 environmental commitment sets our standards for sustainability in order to remain at the forefront of environmentally friendly manufacturing and to provide customers with an assured, ethical a sustainable savoir faire. Together, we find solutions that create the greatest possible effect.

Simply, the better thing you put in, the better things you get out.

AN ERGONOMIC MINDSET

HOW CAN WE MAKE A BETTER DAY EVERY TIME YOU SIT?

We at Spaceform are committed in producing high quality, stylish and ergonomically designed seating to satisfy the demands that embrace physical and mental issues as well as the wider social working environment. This philosophy affects all processes. To be “better while sitting”, ergonomics become a significant aspect to guide the development of any of our products.

Ergonomics is much more than just good desks, seating and chairs. It’s about looking after the whole person and the sense of mental and physical balance. It is about the inter-relation between the individual, technology and the design of the entire workplace.



ABOUT SPACEFORM

DESIGN, COMFORT E FUNZIONALITÀ.

SPACEFORM, una realtà moderna e dinamica che pone le sue basi nel recente decennio. Siamo ad oggi un'azienda familiare che opera con una visione internazionale nella produzione di sedute per l'ufficio, per la comunità e per il contract. Fin dall'inizio la compagnia ha sviluppato un approccio che combina esperienza tecnica, flessibilità, ricerca e spirito d'avventura: il tutto focalizzato in un'azione: LA CURA DEI DETTAGLI. Creiamo arredi funzionali, di alta qualità e comfort. Prodotti dal design distintivo immediatamente riconoscibile. Il nostro impegno è creare soluzioni legate alla qualità, all'estetica e all'ergonomia, disegnate per rendere gli spazi funzionali e pratici, compiacenti con i bisogni dei clienti e degli stili di vita. Interagiamo in maniera diretta con una clientela internazionale di standard elevato e con designers, tutti insieme condividono la passione per la qualità e la creatività che caratterizzano SPACEFORM. Raccogliamo le opinioni uniche sui trend contemporanei e sui modi di viveri negli spazi urbani moderni al fine di soddisfare tutti gli aspetti di una vita moderna. Riteniamo obbligatorio offrire un livello di prodotti e di servizi della più elevata professionalità, ovunque nel mondo ed in ogni fase di ogni progetto. Ogni nostro prodotto è funzionale. Ogni sviluppo dei nostri prodotti è oggetto di cambio nel suo obiettivo di un continuo miglioramento. Ogni nostro nuovo prodotto è una nuova sfida alla quale ci raffrontiamo sempre con lo stesso entusiasmo e con linguaggio contemporaneo. Ogni nostro prodotto è tanto piacevole quanto utile.

VISIONE

SPACEFORM vuole essere un fornitore leader di arredi innovativi, funzionali e di alta qualità per il mercato contract e degli spazi pubblici basandosi su strategie e visioni consumer oriented dove il cliente è la figura centrale a cui offrire la massima qualità del prodotto.

UNA VITA MIGLIORE MENTRE SIAMO SEDUTI

Crediamo in una migliore qualità di vita mentre siamo seduti, al lavoro così come nell'attesa. In SPACEFORM non ci limitiamo a vendere arredi. Soddisfando i vostri bisogni con prodotti e servizi, forniamo soluzioni stimolanti ed emozioni per aiutare il vostro corpo e la vostra mente.

ATTIVITÀ

Utilizzando metodi di costruzione innovativi, materiali nuovi ed eco-sostenibili, SPACEFORM opera al fine di risolvere problemi, di costruire oggetti, prodotti, progetti e servizi. Semplicemente operiamo negli spazi al fine di renderli pratici, piacevoli e a misura del cliente.

LA SCOPERTA AD OGNI LIVELLO

Passo dopo passo, guardiamo al modo in cui i nostri prodotti possono essere la risposta alle diverse richieste del mondo del lavoro, avendo sempre in mente che la vera scoperta non consiste in inventare nuovi prodotti ma nel vederli con occhi diversi.

IL NOSTRO IMPEGNO DI ECO-SOSTENIBILITÀ

RINNOVARE - RICICLARE – RIDURRE – MATERIE PRIME - RINFRESCARE

Monitoriamo e continuamente revisiamo le nostre performance al fine di assicurare un metodo di produzione che sia il più sostenibile e responsabile possibile.

Rendere la vita migliore al lavoro consiste nella ricerca del potenziale intrinseco di ogni cosa. E' l'inizio di una catena a reazione che ruota intorno al nostro impegno ambientale R5 sviluppato per incoraggiarci alla creazione di ambienti salutaris, produttivi e di benessere. Ci responsabilizziamo nell'intera catena. Dalla ricerca delle Materie Prime ai processi produttivi, dall'Impatto Ambientale all'approvvigionamento. Desideriamo continuamente Ridurre il nostro consumo di energia e gli sprechi produttivi. Miriamo a fornire soluzioni di qualità dal carattere brillante e lineare, di estrema abilità e cooperazione, ergonomiche e di origine Riciclata. Offriamo ai nostri clienti la possibilità di avere prodotti professionalmente Rinnovati o di rinunciarvi in maniera eco-sostenibile al fine di ridurre il consumo degli scarti. Scegliere prodotti più salutaris e più produttivi significa al tempo stesso sviluppare un business più sostenibile e vincente.

Il nostro impegno ambientale R5 stabilisce i nostri standard di comportamento con lo scopo di rimanere sempre all'avanguardia nel processo di produzione eco-sostenibile e di fornire ai nostri clienti un savoir faire sicuro, etico e sostenibile.

Insieme ricerchiamo soluzioni che generino I migliori effetti possibile.

Semplicemente, migliori sono gli ingredienti, migliori sono i risultati ottenuti.

ERGONOMIA ALLA BASE

COME POSSIAMO RENDERE LA TUA GIORNATA MIGLIORE MENTRE SEI SEDUTO?

La nostra dedizione è quella di produrre sedute d'arredo di alta qualità, stile e disegno ergonomico per soddisfare le domande che scaturiscono da bisogni fisici e mentali e le richieste sempre più varie degli ambienti di lavoro.

Questa filosofia influenza tutti i processi. Sentirsi meglio mentre "ci si trova seduti" conferma l'ergonomia quale aspetto centrale nello sviluppo dei nostri prodotti.

Ergonomia è molto più che buoni prodotti, sedute, scrivanie o sedie. E' la ricerca e la cura dell'intera persona. E' il senso di un equilibrio fisico-mentale.

Riguarda l'interrelazione tra l'individuo, la tecnologia ed il design dell'intero ambiente lavorativo.



SOFT SEATING



HAMMER

MODULAR **SOLID** SOFA SYSTEM.



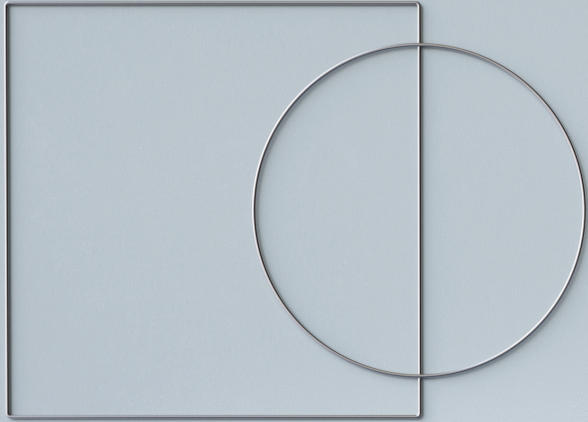

Modular solid sofa system made by sitting and backrests components. The strict cubic geometry makes HAMMER ideal for waiting room and formal lounge applications. HAMMER has a strong presence with its firm expression and fixed upholstery where the clean lines are as important as functionality and comfort. The expression of the sofa can vary depending on the colour and structure of the upholstery which make HAMMER even more versatile.

Sistema di divani compatti e modulari composto da elementi di seduta e schienali. La forma estremamente geometrica rende HAMMER ideale per il suo uso in sale di attesa ed aree formali. HAMMER ha una marcata presenza grazie alla sua forma rigida ed al rivestimento fisso le cui linee pulite sono qualificanti tanto quanto la funzionalità ed il confort del sistema di sedute. La variegata espressione del prodotto si allaccia alla gamma e struttura dei colori che rendono HAMMER ancor più versatile.



HAMMER SOFT SEATING





HAMMER SOFT SEATING

HAMMER is the pure expression of durability. All elements that make a sofa durable - composition, foam, padding - are never directly visible. HAMMER embraces all of them and in addition to a high level of comfort, also boasts strong functional qualities as it can be expanded in an unlimited number of configurations.

HAMMER è la pura espressione della versatilità. Tutti gli elementi che rendono la seduta durevole - i contenuti, le schiume, le imbottiture - non sono mai visibili in primo piano. HAMMER racchiude tutte queste caratteristiche e, in aggiunta ad un elevato livello di confort, esprime una forte funzionalità grazie alle innumerevoli possibili configurazioni. Profondità di seduta e braccioli alti rendono HAMMER la soluzione ideale di seduta in ogni ambiente per ogni tipo di utilizzatore con le proprie abitudini.

HAMMER SOFT SEATING

HAMMER consists of a series of singular elements which can be easily combined and fixed together. Cubical elements recalling the typical shape of a brick. Made by an inner boxed multilayer frame with polyurethane padding in differentiated densities supported by interlaced high resistance elastic belts.

HAMMER consiste in una serie di elementi singoli facilmente aggregabili e bloccabili tra loro. Elementi dalla forma cubica che ricordano la forma del mattone. Struttura interna «scatolata» in multistrato, imbottitura in poliuretano a densità differenziata supportata da cinghie elastiche intrecciate.



HAMMER SOFT SEATING



Elements are available in two different dimensions of width and in misaligned depth to allow any user to create his own configuration based on any space requirement. All elements of the range are supported by sled metal base or low anti-skid glides. HAMMER is also available in fire retardant version so to offer a 360° solution for the contract field as well.

Gli elementi sono disponibili in due diverse larghezze ed in profondità non allineate per consentire ad ogni cliente di creare la propria configurazione a seconda degli spazi disponibili. Tutti gli elementi della collezione sono supportati da un basamento a slitta in metallo o in alternativa da semplici piedini in nylon anti-scivolo. mHAMMER è inoltre disponibile a richiesta nella versione ignifuga così da offrire una soluzione a 360° anche nelle applicazioni contract.





PALLET

LAYING DOWN ON A **PLATFORM.**





PALLET SOFT SEATING



A modular sofa system inspired by traditional loading pallet, giving rise to the distinctive base detail. PALLET is a very generously proportioned and extremely comfortable low seating system with a wooden basement reminding a solid platform. Available in a wide range of configurations, with integrated storage and armrests. Produced from CMHR foam over a ply and hardwood basement with solid and veneered oak, this system allows countless of configurations.

Sistema di sedute modulari ispirato dal tradizionale pallet di carico che evidenzia i dettagli dell'unicità dal basamenti. PALLET è un sistema di sedute basse, proporzionalmente generoso ed estremamente confortevole supportato da un basamento di legno che richiama la compattezza di una piattaforma. Disponibile in un'ampia varietà di configurazioni con compartimenti integrati e braccioli. Prodotto con schiume CMHR con basamento in legno massiccio di rovere questo sistema conta con innumerevoli configurazioni.



Cubical seat, arms and backrest cushions contribute to build personal solutions according to the area of use. The essence of the system is represented by the platform supporting the cushions, symbolizing a pallet on top of which bricks are setting down. The entire system stands on the platform which is the base for the complementary range of the entire system.

Sedute cubiche, braccioli e schienali contribuiscono a costruire soluzioni personali a seconda dell'area d'uso. L'essenza del sistema è rappresentata dalla piattaforma che sostiene le sedute, simbolizzando un Pallet sopra il quale vengono fissati svariati mattoni. L'intero sistema si sostiene sulla piattaforma che allo stesso tempo rappresenta la base degli elementi complementari dell'intera collezione.





PALLET SOFT SEATING

Pallet offers two platforms depth. The one flushed to backrest for compact areas suitable for contract use and more formal common decorations. More generous measurements for a deeper platform to decorate wider areas in a sort of back-shelving system for a homey perception. Straight lines, wooden feeling to fulfill sophisticated spaces.

Pallet offre 2 profondità di piattaforma. Una base allineata con lo schienale di maggiore compattezza, adatta ad un uso contract e ad ambienti più formali. Una base con una profondità più generosa per arredare ampie aree con una sorta di pianale retro schienale di percezione più residenziale. Linee diritte e la calda sensazione del legno per arredare spazi non banali e sofisticati.

VENEER PLATFORM

Platform in multi-layered veneered in OAK and available in a wide range of finishes. These are thin layers sliced from solid wood of about 0.6 mm thick, glued onto lightweight boards and then covered with clear lacquer. A living material with a natural feel

IRON PLATFORM

Platform in Metal is composed of horizontal beams in rectangular sections matt black painted and cylindrical legs matt black painted or chromed.

PIATTAFORMA DI LEGNO

Piattaforma in multistrato di legno Rovere disponibile in un'ampia gamma di finiture. Sottile lamine di legno massello dello spessore di 0.6 mm, incollate su tavole di portanti e rifinite con laccatura. Un materiale vivo dal tocco naturale.

PIATTAFORMA DI METALLO

La piattaforma di metallo è composta da barre orizzontali in sezione rettangolare verniciate in color nero opaco e da piedini rotondi vernicati nero opaco o cromati.



PALLET SOFT SEATING

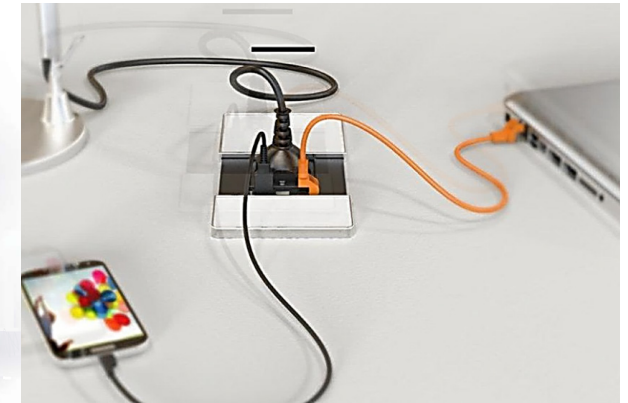



SS007

SYSTEM OF **ELEGANT** LOW BACK SOFAS.





System of elegant low back sofas very much appreciated for the warm welcome it offers guests in waiting areas and also for informal meetings. The collection is a guarantee of elegance with its chrome details and nice comfort thanks to the particular cushioning which is also used for armrests.

This line has been designed to offer a wrap around feeling. The wide selection of finishings and colours, leather included, can have the product placed in any setting with sobriety.

Sistema di eleganti sedute basse estremamente apprezzato per la calda accoglienza offerta all'utilizzatore in sale d'attesa e riunioni informali. La collezione è garanzia di eleganza con i suoi dettagli cromati e l'elevato confort grazie al sistema di cuscini utilizzato anche sui braccioli.

Questa gamma è stata disegnata per trasmettere una sensazione che avvolge completamente la persona. L'ampia scelta delle finiture e dei colori dei tessuti e delle pelli di rivestimento consente di disporre la seduta in ogni ambientazione con sobrietà.





Sofas, modular elements, armchairs and benches with complementary coffee tables. This line has been designed to offer a wraparound feeling. The wide selection of finishing and colours, leather included, can have the product placed in any setting with sobriety.

Divani, elementi modulari, poltrone e panche accompagnati da tavolini bassi. Questa linea è stata disegnata per garantire un feeling completamente avvolgente. L'ampia gamma delle finiture e dei colori, incluse le pelli, consentono alle sedute di essere esposte in ogni tipo di scenografia con estrema sobrietà.





SS010





System of individual seating elements with a distinctive identity. Single, double and three seaters, the line has been designed to offer as an executive seating range for high quality reception and lounge areas. Its style is emphasized by the simple but elegant leg supports emphasising the formal design of the range.

Sistema di elementi di seduta individuali con forte identità. Poltrona, due posti e tre posti, la linea è stata disegnata per rispondere alle esigenze di un prodotto adatto ad aree direzionali e di reception così come di ampia attesa. Il suo stile è enfatizzato dai semplici ed allo stesso tempo eleganti supporti che evidenziano il design formale della gamma.



The chromed details contribute to highlight the overall aesthetic. The wide selection of finishing and colours, leather included, can have the product placed in any setting with sobriety. Although its generous dimensions, the system can be used equally in any small or big area due to its compacted construction shape.

I dettagli cromati contribuiscono ad evidenziare l'estetica delle sedute. L'ampia gamma delle finiture e dei colori, incluse le pelli, consentono alle sedute di essere esposte in ogni tipo di scenografia con estrema sobrietà. Nonostante le dimensioni abbondanti, il sistema si adatta ad essere utilizzato indistintamente in aree di piccole e grandi dimensioni grazie alla compatta forma di fabbricazione.



SS012

A **STRONG** EMBRACING **IDENTITY.**







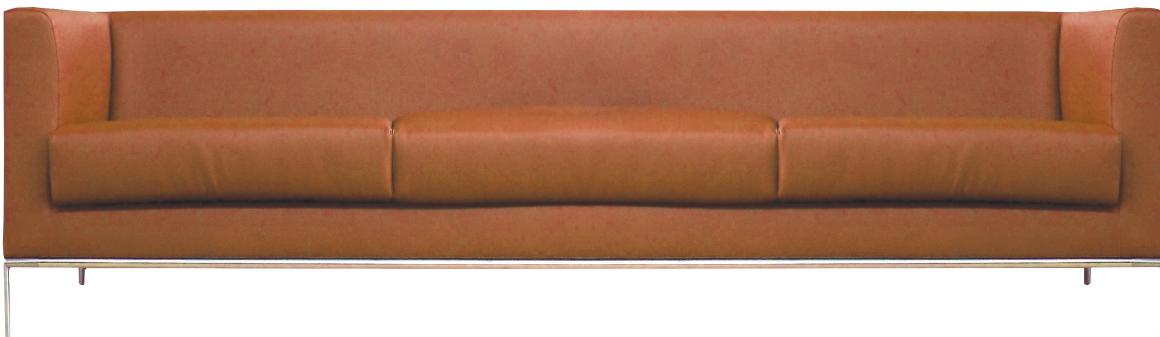

System of sofas with a strong embracing identity. Armchairs, sofas in different sizes designed to offer as an executive seating range for high quality receptions, lounge areas and private offices. Its style is emphasized by the all-around tubular aluminium frame and the elegant and stylish aluminium legs. The balanced proportions are assuring a comfortable and long lasting sitting.

Sistema di elementi di seduta con un'identità avvolgente. Poltrona e divanetti in diverse dimensioni disegnati per offrire una risposta di sedute direzionali per zone di attesa di alto livello, aree lounge ed uffici privati. Il suo stile è enfatizzato dal disegno continuo del basamento in tubo circolare di alluminio e dagli eleganti supporti sempre in alluminio. Le proporzioni bilanciate assicurano un confort di seduta di lunga durata.





The polished chromed details of the aluminum frame embellish the aesthetic of the range. The wide selection of finishing and colours, leather included, can have the product placed in any setting with sobriety.

Although its generous dimensions, the system can be used equally in any small or big area due to its compacted cubical construction shape.

I dettagli lucidi del basamento in alluminio sottolineano la bellezza dell'estetica della gamma. L'ampia gamma delle finiture e dei colori, incluse le pelli, consentono alle sedute di essere esposte in ogni tipo di scenografia con estrema sobrietà.

Nonostante le dimensioni abbondanti, il sistema si adatta ad essere utilizzato indistintamente in aree di piccole e grandi dimensioni grazie alla compatta forma di fabbricazione.





SS016

BOXED ARMCHAIR AND SOFAS.





Range of armchair and sofas with a distinctive “boxed” design. Simple, elegant and inviting, the system can be placed in corporate or hospitality environments to create sumptuous dining, lounge, reception or breakout areas. The family includes sofas and armchair which share the same simple proportions and deep level comfort thanks to the rear falling seat design.

Gamma di poltrone e sedute dall'evidente design cubico. Semplice, elegante ed invitante, il sistema può essere utilizzato indifferentemente in ambienti corporativi o di ospitalità per creare magnifiche aree dining, di reception e di ricreazione. La gamma include divanetti e poltrone che si caratterizzano per le semplici proporzioni e per l'importante livello di confort grazie anche al disegno inclinato delle sedute.





La costruzione in un unico blocco, utilizzata nella seduta e nello schienale, comunica all'utilizzatore un senso di seduta avvolgente senza comprometterne il confort. La versione con schienale livellato si accompagna a quella con schienale più alto. Gambe cilindriche supportano l'intera struttura mentre l'ampia gamma delle finiture e dei colori, incluse le pelli, consentono alle sedute di essere esposte in ogni tipo di scenografia con estrema sobrietà.



The all-in-one construction applied to seat and back gives the user a sense of space from adjoining chairs, without compromising on comfort. A levelled back version is accompanied by a higher back version. Cylindrical legs are supporting the all structure. The wide selection of finishing and colours, leather included, can have the product placed in any setting with sobriety.



SS022

SOFAS WITH A DISTINCTIVE
EXECUTIVE IDENTITY.





System of sofas with a distinctive executive identity. Armchairs, sofas in different sizes designed to offer as an executive seating range for high quality receptions, lounge areas and private offices. The collection is a guarantee of elegance with its chrome details and nice comfort. The balance between seat and back cushioning is assuring a comfortable and long lasting sitting.

Sistema di sedute con una chiara identità direzionale. Poltrone e divanetti in differenti misure disegnati quali sedute di livello per aree di reception, lounge ed uffici privati. La collezione è una garanzia di eleganza grazie ai suoi dettagli di cromature ed al perfetto confort. L'equilibrio tra i cuscini di seduta e schienale garantisce un confort di lunga durata.



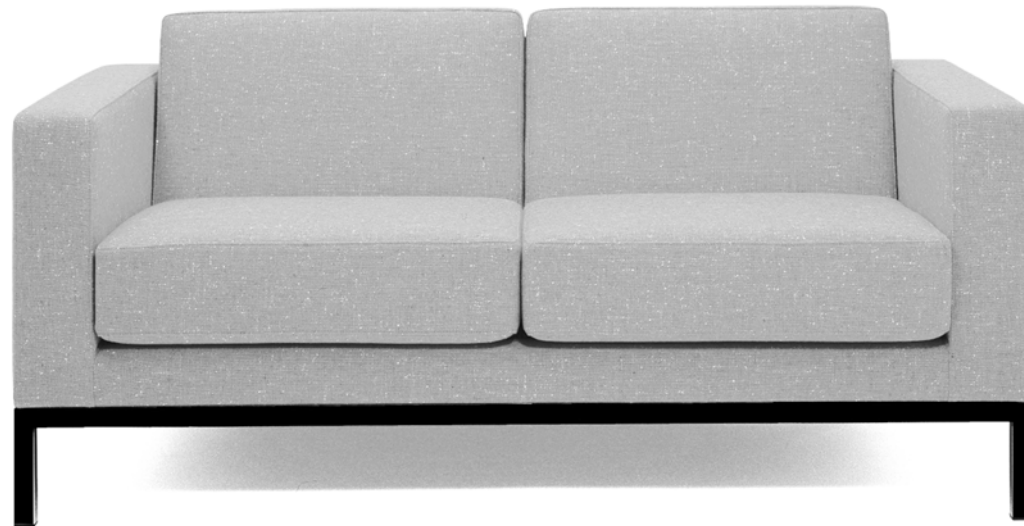

The chromed details of the frame embellish the aesthetic of the range. The wide selection of finishing and colours, leather included, can have the product placed in any setting with sobriety. Although its generous dimensions, the system can be used equally in any small or big area due to its compacted cubical construction shape.

I dettagli cromati della struttura impreziosiscono l'estetica della gamma. L'ampia gamma delle finiture e dei colori, incluse le pelli, consentono alle sedute di essere esposte in ogni tipo di scenografia con estrema sobrietà. Nonostante le dimensioni abbondanti, il sistema si adatta ad essere utilizzato indistintamente in aree di piccole e grandi dimensioni grazie alla compatta forma di fabbricazione.



Moreover, the collection offers a range of single seater armchairs of a more casual look, supported by metal bases allowing wider possibilities of use of the entire collection. In addition, a second option of sofa base with higher visible metal sides giving a «wrapping» feeling and a more industrial design look is also available.

La collezione offre inoltre una serie di sedute singole d'attesa più informali supportate da basamenti metallici che diversificano ed ampliano le possibilità di utilizzo dell'intera linea. In aggiunta, su tutta la linea, vi è una seconda opzione di basamento con laterali a vista che «racchiudono» l'estetica dell'intero divano dandone un'apparenza ancor più industriale.





... GIVE US **IDEAS**
WE MAKE THEM **HAPPEN.**

OVERVIEW & DIMENSIONS



BASE

Seating elements are sustained by full depth sled steel base with a flat thin design of 50mm thickness, chromed or black powder coated. Alternatively, by low anti-skid glides in black Nylon.

UPHOLSTERY

HAMMER can be upholstered in a wide range of contract fabrics, eco-leathers and genuine leathers from Spaceform's standard upholstery collection. Customer's Own material – fabrics and leathers – are applicable subject to Spaceform's approval after testing the submitted samples.

BASAMENTO

Gli elementi sono sostenuti da basi a slitta in metallo a profondità intera dal profilo sottile di spessore 50mm, cromate or verniciate a polveri. In alternativa si possono usare dei piedini bassi in Nylon nero.

RIVESTIMENTI

HAMMER può essere rivestito in un'ampia gamma di tessuti contract, in eco-pelli e pelli naturali della collezione di rivestimenti Spaceform. L'uso di materiali cliente – tessuti o pelli – è consentito previo approvazione di Spaceform dopo aver testato i relativi campioni.

STANDARD MODULES

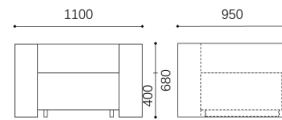

SS.HMR.1S - Sofa 1 seater

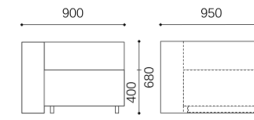

SS.HMR.E1 - End Element R/L

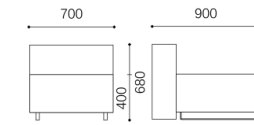

SS.HMR.C1 - Central Element

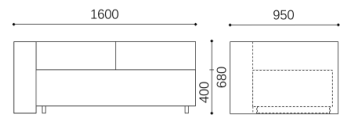

SS.HMR.E2 - End el. 2 seater R/L

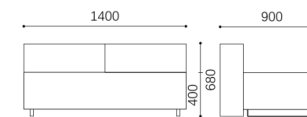

SS.HMR.C2 - Central El. 2 seater

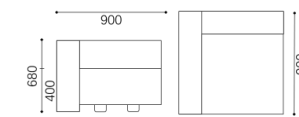

SS.HMR.CE - Corner Element

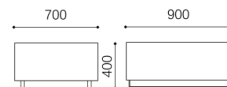

SS.HMR.P1 - Ottoman 1 seater

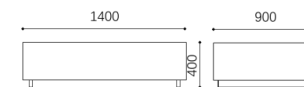

SS.HMR.P2 - Ottoman 2 seater

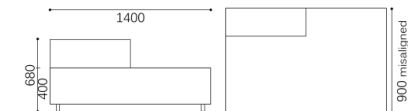

SS.HMR.I2 - Island El. Misaligned R/L

LARGE MODULES

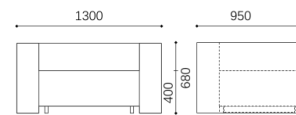

SS.HML.1S - Sofa 1 seater

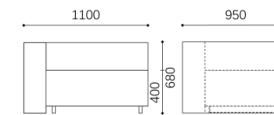

SS.HML.E1 - End Element

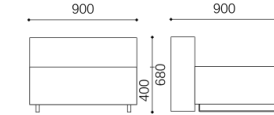

SS.HML.C1 - Central Element

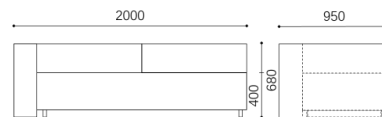

SS.HML.E2 - End el. 2 seater

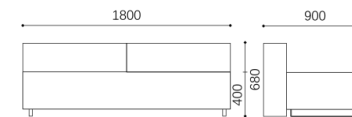

SS.HML.C2 - Central El. 2 seater

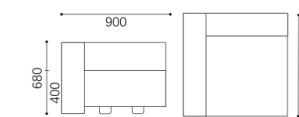

SS.HML.CE - Corner Element

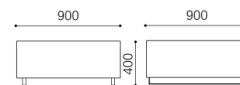

SS.HML.P1 - Ottoman 1 seater

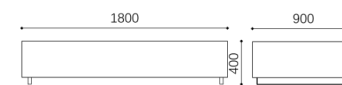

SS.HML.P2 - Ottoman 2 seater

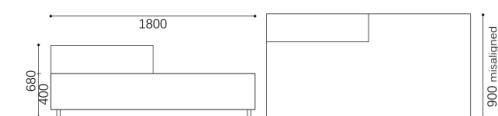

SS.HML.I2 - Island El. Misaligned



VENEER PLATFORM

Platform in multi-layered veneered in OAK and available in a wide range of finishes. These are thin layers sliced from solid wood of about 0.6 mm thick, glued onto lightweight boards and then covered with clear lacquer. A living material with a natural feel.

IRON PLATFORM

Platform in Metal is composed of horizontal beams in rectangular sections matt black painted and cylindrical legs matt black painted or chromed.

UPHOLSTERY

PALLET can be upholstered in a wide range of contract fabrics and eco-leathers and leathers from Spaceform's standard upholstery collection. Customer's Own material – fabrics and leathers – are applicable subject to Spaceform approval after testing the submitted samples.

PIATTAFORMA DI LEGNO

Piattaforma in multistrato di legno Rovere disponibile in un'ampia gamma di finiture. Sottile lamine di legno massello dello spessore di 0.6 mm, incollate su tavole di portanti e rifinite con laccatura. Un materiale vivo dal tocco naturale.

PIATTAFORMA DI METALLO

La piattaforma di metallo è composta da barre orizzontali in sezione rettangolare verniciate in color nero opaco e da piedini rotondi verniciati nero opaco o cromati.

RIVESTIMENTI

PALLET può essere rivestito in un'ampia gamma di tessuti contract, in eco-pelli e pelli naturali della collezione di rivestimenti Spaceform.

L'uso di materiali cliente – tessuti o pelli – è consentito previo approvazione di Spaceform dopo aver testato i relativi campioni.

WOODEN PLATFORM

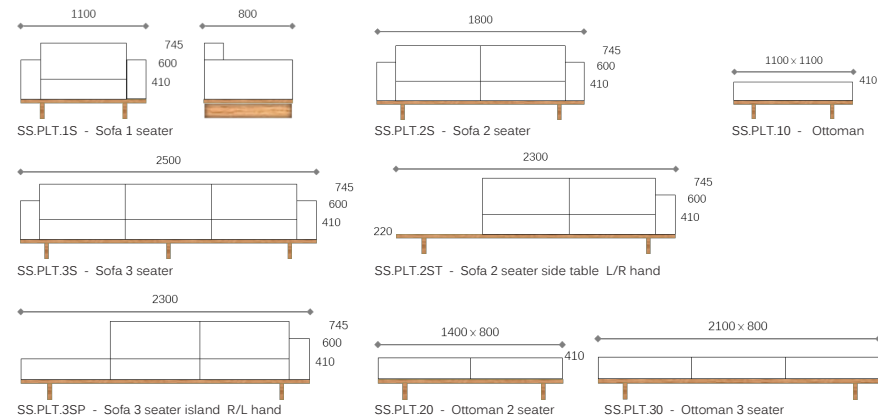

IRON PLATFORM

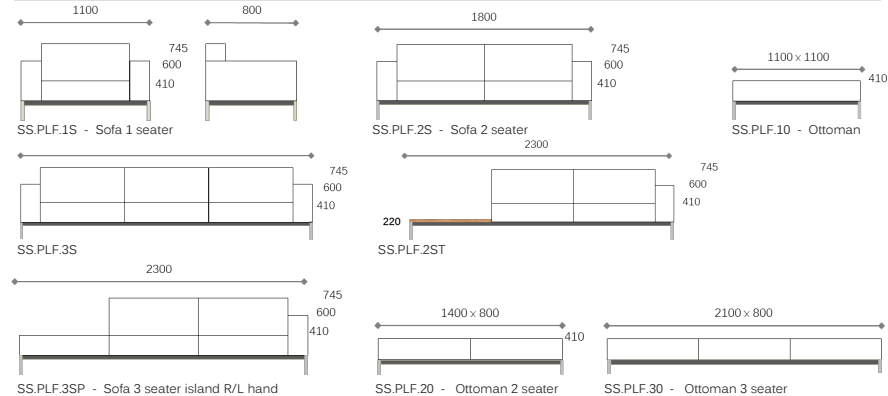

LARGE WOODEN PLATFORM

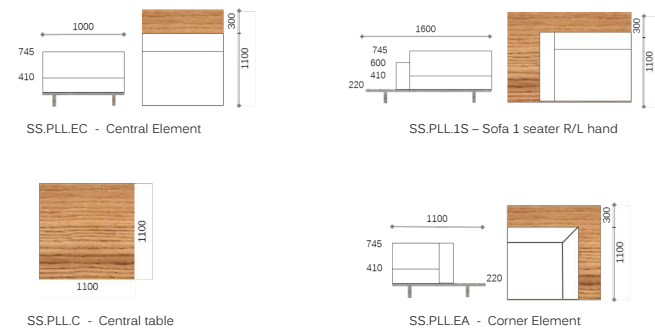



BASE

Seating elements are sustained by full depth sled steel base with a flat thin design of 50mm thickness, chromed or black powder coated. Alternatively, by low anti-skid glides in black Nylon

UPHOLSTERY

SS007 can be upholstered in a wide range of contract fabrics, eco-leathers and genuine leathers from Spaceform's standard upholstery collection. Customer's Own material – fabrics and leathers – are applicable subject to Spaceform's approval after testing the submitted samples.

BASAMENTO

Gli elementi sono sostenuti da basi a slitta in metallo a profondità intera dal profilo sottile di spessore 50mm, cromate o verniate a polveri. In alternativa si possono usare dei piedini bassi in Nylon nero.

RIVESTIMENTI

SS007 può essere rivestito in un'ampia gamma di tessuti contract, in eco-pelli e pelli naturali della collezione di rivestimenti Spaceform.

L'uso di materiali cliente – tessuti o pelli – è consentito previo approvazione di Spaceform dopo aver testato i relativi campioni.

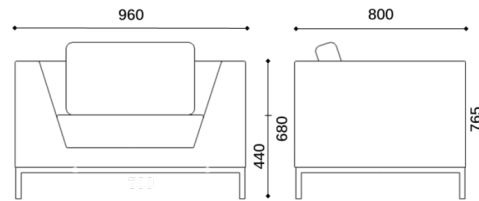

SS.007.1S - Armchair

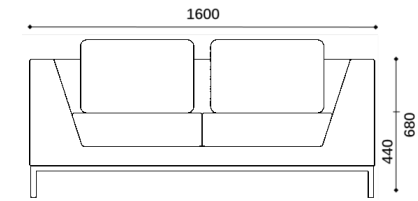

SS.007.2S - Sofa 2 seater

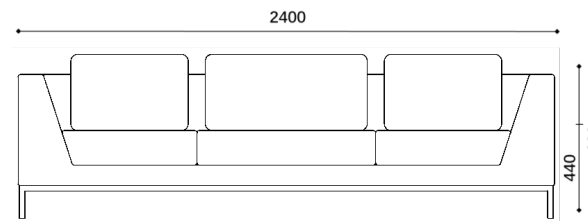

SS.007.3S - Sofa 3 seater

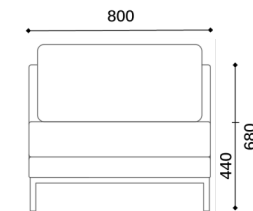

SS.007.1P - Single element

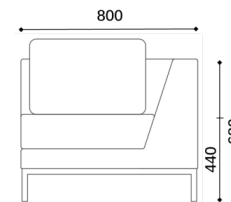

SS.007.1C - Corner element

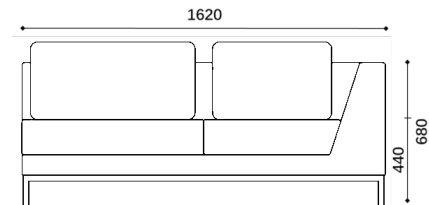

SS.007.2P.L-R - 2 seater element R/L hand

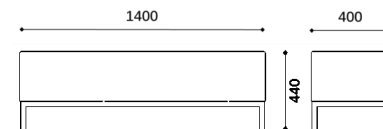

SS.007.PR - Rectangular bench

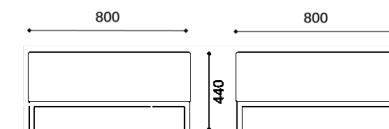

SS.007.PQ - Square bench



BASE

Square tubular Steel frame finished with epoxy powder coating or chromed.

UPHOLSTERY

SS010 can be upholstered in a wide range of contract fabrics, eco-leathers and genuine leathers from Spaceform's standard upholstery collection. Customer's Own material – fabrics and leathers – are applicable subject to Spaceform's approval after testing the submitted samples.

BASAMENTO

Base in tubo metallo sezione quadrata, verniciata a polveri epossidiche o cromato.

RIVESTIMENTI

SS010 può essere rivestito in un'ampia gamma di tessuti contract, in eco-pelli e pelli naturali della collezione di rivestimenti Spaceform. L'uso di materiali cliente – tessuti o pelli – è consentito previo approvazione di Spaceform dopo aver testato i relativi campioni.

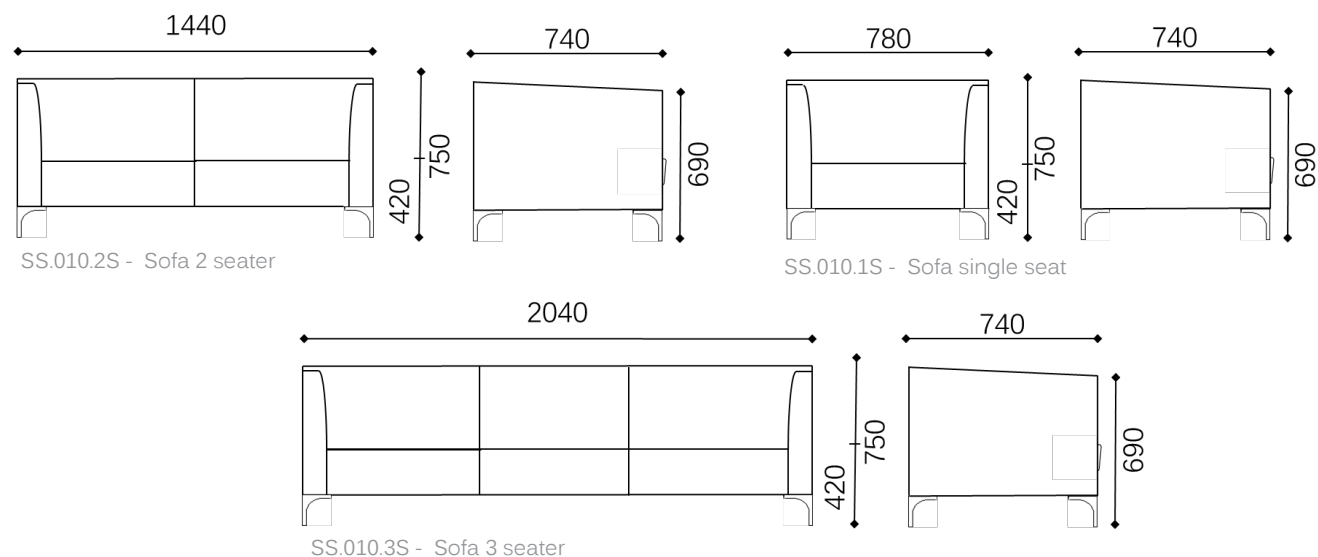



BASE

Tubular aluminium frame and cast aluminium round legs polished chromed or powder coated finished.

UPHOLSTERY

SS012 can be upholstered in a wide range of contract fabrics, eco-leathers and genuine leathers from Spaceform's standard upholstery collection. Customer's Own material – fabrics and leathers – are applicable subject to Spaceform's approval after testing the submitted samples.

BASAMENTO

Base tubolare di alluminio con piedini in fusione di alluminio con finitura lucida o verniciata a polveri epossidiche.

RIVESTIMENTI

SS012 può essere rivestito in un'ampia gamma di tessuti contract, in eco-pelli e pelli naturali della collezione di rivestimenti Spaceform. L'uso di materiali cliente – tessuti o pelli – è consentito previo approvazione di Spaceform dopo aver testato i relativi campioni.

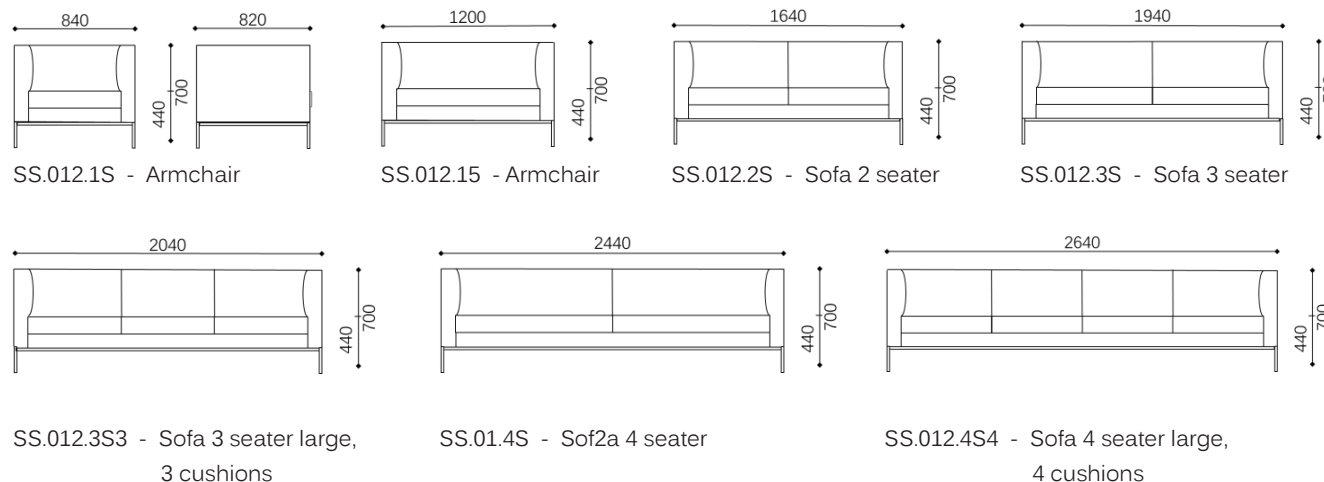



BASE

Cylindrical Steel legs finished with epoxy powder coating or chromed.

UPHOLSTERY

SS016 can be upholstered in a wide range of contract fabrics, eco-leathers and genuine leathers from Spaceform's standard upholstery collection. Customer's Own material – fabrics and leathers – are applicable subject to Spaceform's approval after testing the submitted samples.

BASAMENTO

Gambe cilindriche verniciate a polveri epossidiche oppure cromate.

RIVESTIMENTI

SS016 può essere rivestito in un'ampia gamma di tessuti contract, in eco-pelli e pelli naturali della collezione di rivestimenti Spaceform. L'uso di materiali cliente – tessuti o pelli – è consentito previo approvazione di Spaceform dopo aver testato i relativi campioni.

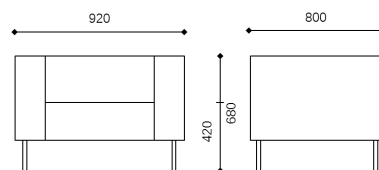

SS.016.1S - Armchair

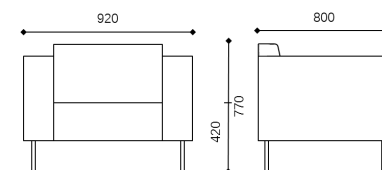

SS.016.1A - Armchair high back

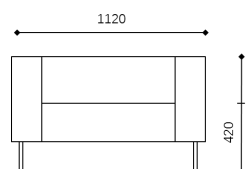

SS.016.1S2 - Large armchair

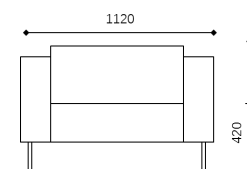

SS.016.1A2 - Large armchair high back

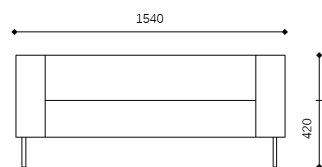

SS.016.2S - 2 seater sofa

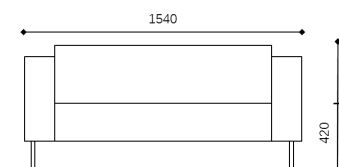

SS.016.2A - 2 seater sofa high back

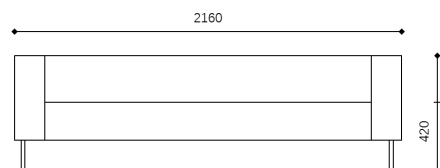

SS.016.3S - 3 seater sofa

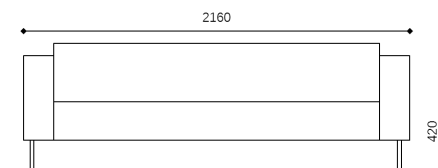

SS.016.3A - 3 seater high back

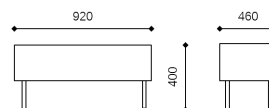

SS.016.P9
Ottoman

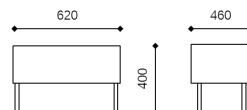

SS.016.P6
Ottoman

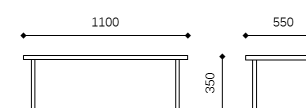

SS.016.TR
rectangular table

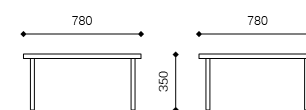

SS.016.TQ
square table



BASE

Square tubular Steel frame finished with epoxy powder coating or chromed.

UPHOLSTERY

SS022 can be upholstered in a wide range of contract fabrics, eco-leathers and genuine leathers from Spaceform's standard upholstery collection. Customer's Own material – fabrics and leathers – are applicable subject to Spaceform's approval after testing the submitted samples.

BASAMENTO

Base in tubo metallo sezione quadrata, verniciata a polveri epossidiche o cromato.

RIVESTIMENTI

SS022 può essere rivestito in un'ampia gamma di tessuti contract, in eco-pelli e pelli naturali della collezione di rivestimenti Spaceform. L'uso di materiali cliente – tessuti o pelli – è consentito previo approvazione di Spaceform dopo aver testato i relativi campioni.

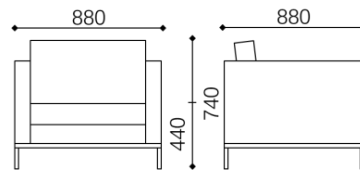

SS.022.1S - Sofa single seat

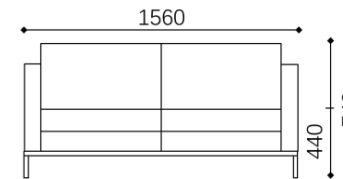

SS.022.2S - Sofa 2 seater

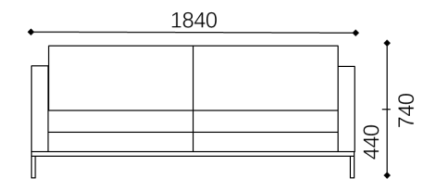

SS.022.2S2 - Sofa 3 seater

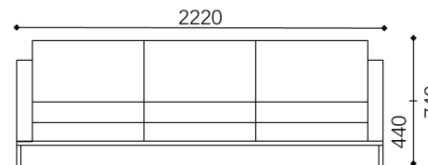

SS.022.3S - Sofa 3 seater large

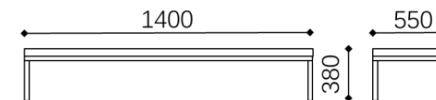

SS.022.TR - Low table



Sspace S.r.l

Via Mottarone 36D
21100 Varese
Italy

Tel +39 0332 1646541
Fax +39 0332 1641342
info@spaceform.it
www.spaceform.it

