



# CATALOGUE

2017-2018



... GIVE US **IDEAS**  
WE MAKE THEM **HAPPEN.**

INDEX

<b>About the company</b>	p.05
<b>Soft seating</b>	p.10
<b>Hammer</b>	p.11
<b>Pallet</b>	p.19
<b>SS007</b>	p.26
<b>SS010</b>	p.33
<b>SS012</b>	p.37
<b>SS016</b>	p.45
<b>SS022</b>	p.51
<b>Breakout&amp;Chair</b>	p.58
<b>8Cube</b>	p.59
<b>SS031, SS032, SS036</b>	p.63
<b>SS033</b>	p.67
<b>SS034</b>	p.71
<b>SS035</b>	p.75
<b>SS037</b>	p.79
<b>SS038</b>	p.83
<b>SS040</b>	p.87
<b>SS042</b>	p.93
<b>Office</b>	p.98
<b>PAK Chair</b>	p.99
<b>MIR Chair</b>	p.107
<b>MIR3 Chair</b>	p.113

<b>Overview&amp;Dimensions</b>	p.118
<b>Hammer</b>	p.119
<b>Pallet</b>	p.120
<b>SS007</b>	p.121
<b>SS010</b>	p.122
<b>SS012</b>	p.123
<b>SS016</b>	p.124
<b>SS022</b>	p.125
<b>8Cube</b>	p.126
<b>SS031, SS032, SS036</b>	p.127
<b>SS033</b>	p.128
<b>SS034</b>	p.129
<b>SS035</b>	p.130
<b>SS037</b>	p.131
<b>SS038</b>	p.132
<b>SS040</b>	p.133
<b>SS042</b>	p.134
<b>PAK Chair</b>	p.135
<b>MIR Chair</b>	p.136
<b>MIR3 Chair</b>	p.137

# ABOUT THE COMPANY

# ABOUT SPACEFORM

## DESIGN, COMFORT and FUNZIONALITY

SPACEFORM is a dynamic and modern company that lays its foundations in the recent decade. Today we are a local owned family company operating with an international eye in the manufacturing of seating products for offices, communities and contract. From the very beginning the company has implemented an approach which combines technical expertise, flexibility, research and spirit of adventure: all focused on one action: CARE of DETAILS.

We create innovative, functional and high-quality furniture. High-quality products with a distinctive design that is immediately recognizable. Our commitment is to create comfortable and functional environments, designed to make spaces a more practical and pleasant environments, tailor made on customer needs. We interact closely with a clientele of high international standards and designers who all share the passion for quality and creativity that characterizes SPACEFORM. They give us their unique opinion on the current trends and the way we live now into the urban audience so to accomodate all aspects of modern lifestyles. We believe mandatory to offer a level of products and services of the highest professionalism, everywhere in the world in every phase of the project progress. Every of our product is functional. Every of our product development is subject to change in its attempt to get better. Every of our new product is a new challenge and we look into it with the same enthusiasm. Every of our product is as beautiful as useful.

## VISION

SPACEFORM shall be a leading provider of innovative, functional and high-quality furniture for hospitality and public spaces being based on consumer oriented visions and strategies where the client is the focus to offer the best product quality.

## MAKING LIFE BETTER WHILE SITTING

We believe in making life better when sitting, at work or while waiting. At Spaceform we do more than just selling furniture. With products and services to match your needs, we deliver inspiring and exciting solutions to help your body and mind.

## OPERATIONS

By using innovative constructions, new and eco-friendly materials SPACEFORM operates to solve problems, to build «things», products, projects and services. Simply we operate within spaces to make them practical, pleasant and tailor made on customer needs.

## DISCOVERING ON EVERY LEVEL

Step by step, we look at ways our products can provide solutions for a range of common demands on the workplace by having in mind that the real discovery does not consist in creating new products but in seeing them with new eyes.

## OUR SUSTAINABILITY COMMITMENT

RENOVATE - RECYCLE – REDUCE - RAW MATERIALS - REFRESH AIR

We regularly monitor and review our performance to ensure we manufacture in the most sustainable and responsible manner. Making life better when sitting is about seeing the inner potential in everything . It is the start of a chain reaction. A chain reaction that rotates around our R5 environmental commitment developed to encourage us to create environments that generate health, well-being and productivity. We take responsibility for the entire chain. From Raw Material to manufacturing processes, from Air impacts to refurbishment. . We yearn for continually Reducing our energy consumption and waste of production. We aim to provide quality solutions characterized by pure and smart resources, craftsmanship, cooperation, Recycling and ergonomics. We offer customers the option of having old products professionally Renewed or disposed of in a sustainable and environmentally friendly manner to minimize waste consumption. Choosing a healthier, happier and more productive products it also means a more successful and more sustainable business.

Our R5 environmental commitment sets our standards for sustainability in order to remain at the forefront of environmentally friendly manufacturing and to provide customers with an assured, ethical a sustainable savoir faire. Together, we find solutions that create the greatest possible effect.

Simply, the better thing you put in, the better things you get out.

## AN ERGONOMIC MINDSET

HOW CAN WE MAKE A BETTER DAY EVERY TIME YOU SIT?

We at Spaceform are committed in producing high quality, stylish and ergonomically designed seating to satisfy the demands that embrace physical and mental issues as well as the wider social working environment. This philosophy affects all processes. To be “better while sitting”, ergonomics become a significant aspect to guide the development of any of our products.

Ergonomics is much more than just good desks, seating and chairs. It’s about looking after the whole person and the sense of mental and physical balance. It is about the inter-relation between the individual, technology and the design of the entire workplace.



# ABOUT SPACEFORM

## DESIGN, COMFORT E FUNZIONALITÀ.

*SPACEFORM, una realtà moderna e dinamica che pone le sue basi nel recente decennio. Siamo ad oggi un'azienda familiare che opera con una visione internazionale nella produzione di sedute per l'ufficio, per la comunità e per il contract. Fin dall'inizio la compagnia ha sviluppato un approccio che combina esperienza tecnica, flessibilità, ricerca e spirito d'avventura: il tutto focalizzato in un'azione: LA CURA DEI DETTAGLI. Creiamo arredi funzionali, di alta qualità e comfort. Prodotti dal design distintivo immediatamente riconoscibile. Il nostro impegno è creare soluzioni legate alla qualità, all'estetica e all'ergonomia, disegnate per rendere gli spazi funzionali e pratici, compiacenti con i bisogni dei clienti e degli stili di vita. Interagiamo in maniera diretta con una clientela internazionale di standard elevato e con designers, tutti insieme condividono la passione per la qualità e la creatività che caratterizzano SPACEFORM. Raccogliamo le opinioni uniche sui trend contemporanei e sui modi di viveri negli spazi urbani moderni al fine di soddisfare tutti gli aspetti di una vita moderna. Riteniamo obbligatorio offrire un livello di prodotti e di servizi della più elevata professionalità, ovunque nel mondo ed in ogni fase di ogni progetto. Ogni nostro prodotto è funzionale. Ogni sviluppo dei nostri prodotti è oggetto di cambio nel suo obiettivo di un continuo miglioramento. Ogni nostro nuovo prodotto è una nuova sfida alla quale ci raffrontiamo sempre con lo stesso entusiasmo e con linguaggio contemporaneo. Ogni nostro prodotto è tanto piacevole quanto utile.*

## VISIONE

*SPACEFORM vuole essere un fornitore leader di arredi innovativi, funzionali e di alta qualità per il mercato contract e degli spazi pubblici basandosi su strategie e visioni consumer oriented dove il cliente è la figura centrale a cui offrire la massima qualità del prodotto.*

## UNA VITA MIGLIORE MENTRE SIAMO SEDUTI

*Crediamo in una migliore qualità di vita mentre siamo seduti, al lavoro così come nell'attesa. In SPACEFORM non ci limitiamo a vendere arredi. Soddisfando i vostri bisogni con prodotti e servizi, forniamo soluzioni stimolanti ed emozioni per aiutare il vostro corpo e la vostra mente.*

## ATTIVITÀ

*Utilizzando metodi di costruzione innovativi, materiali nuovi ed eco-sostenibili, SPACEFORM opera al fine di risolvere problemi, di costruire oggetti, prodotti, progetti e servizi. Semplicemente operiamo negli spazi al fine di renderli pratici, piacevoli e a misura del cliente.*

## LA SCOPERTA AD OGNI LIVELLO

*Passo dopo passo, guardiamo al modo in cui i nostri prodotti possono essere la risposta alle diverse richieste del mondo del lavoro, avendo sempre in mente che la vera scoperta non consiste in inventare nuovi prodotti ma nel vederli con occhi diversi.*



## IL NOSTRO IMPEGNO DI ECO-SOSTENIBILITÀ

RINNOVARE - RICICLARE – RIDURRE – MATERIE PRIME - RINFRESCARE

*Monitoriamo e continuamente revisiamo le nostre performance al fine di assicurare un metodo di produzione che sia il più sostenibile e responsabile possibile.*

*Rendere la vita migliore al lavoro consiste nella ricerca del potenziale intrinseco di ogni cosa. E' l'inizio di una catena a reazione che ruota intorno al nostro impegno ambientale R5 sviluppato per incoraggiarci alla creazione di ambienti salutaris, produttivi e di benessere. Ci responsabilizziamo nell'intera catena. Dalla ricerca delle Materie Prime ai processi produttivi, dall'Impatto Ambientale all'approvvigionamento. Desideriamo continuamente Ridurre il nostro consumo di energia e gli sprechi produttivi. Miriamo a fornire soluzioni di qualità dal carattere brillante e lineare, di estrema abilità e cooperazione, ergonomiche e di origine Riciclata. Offriamo ai nostri clienti la possibilità di avere prodotti professionalmente Rinnovati o di rinunciarvi in maniera eco-sostenibile al fine di ridurre il consumo degli scarti. Scegliere prodotti più salutaris e più produttivi significa al tempo stesso sviluppare un business più sostenibile e vincente.*

*Il nostro impegno ambientale R5 stabilisce i nostri standard di comportamento con lo scopo di rimanere sempre all'avanguardia nel processo di produzione eco-sostenibile e di fornire ai nostri clienti un savoir faire sicuro, etico e sostenibile.*

*Insieme ricerchiamo soluzioni che generino I migliori effetti possibile.*

*Semplicemente, migliori sono gli ingredienti, migliori sono i risultati ottenuti.*

## ERGONOMIA ALLA BASE

COME POSSIAMO RENDERE LA TUA GIORNATA MIGLIORE MENTRE SEI SEDUTO?

*La nostra dedizione è quella di produrre sedute d'arredo di alta qualità, stile e disegno ergonomico per soddisfare le domande che scaturiscono da bisogni fisici e mentali e le richieste sempre più varie degli ambienti di lavoro.*

*Questa filosofia influenza tutti i processi. Sentirsi meglio mentre "ci si trova seduti" conferma l'ergonomia quale aspetto centrale nello sviluppo dei nostri prodotti.*

*Ergonomia è molto più che buoni prodotti, sedute, scrivanie o sedie. E' la ricerca e la cura dell'intera persona. E' il senso di un equilibrio fisico-mentale.*

*Riguarda l'interrelazione tra l'individuo, la tecnologia ed il design dell'intero ambiente lavorativo.*



# SOFT SEATING



# HAMMER

MODULAR **SOLID** SOFA SYSTEM.



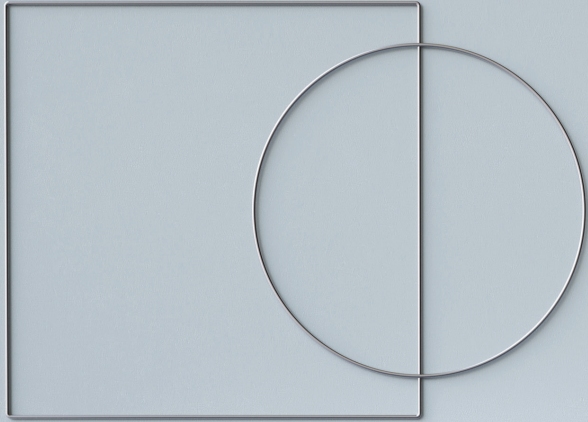

Modular solid sofa system made by sitting and backrests components. The strict cubic geometry makes HAMMER ideal for waiting room and formal lounge applications. HAMMER has a strong presence with its firm expression and fixed upholstery where the clean lines are as important as functionality and comfort. The expression of the sofa can vary depending on the colour and structure of the upholstery which make HAMMER even more versatile.

*Sistema di divani compatti e modulari composto da elementi di seduta e schienali. La forma estremamente geometrica rende HAMMER ideale per il suo uso in sale di attesa ed aree formali. HAMMER ha una marcata presenza grazie alla sua forma rigida ed al rivestimento fisso le cui linee pulite sono qualificanti tanto quanto la funzionalità ed il confort del sistema di sedute. La variegata espressione del prodotto si allaccia alla gamma e struttura dei colori che rendono HAMMER ancor più versatile.*



# HAMMER SOFT SEATING





# HAMMER SOFT SEATING

HAMMER is the pure expression of durability. All elements that make a sofa durable - composition, foam, padding - are never directly visible. HAMMER embraces all of them and in addition to a high level of comfort, also boasts strong functional qualities as it can be expanded in an unlimited number of configurations.

*HAMMER è la pura espressione della versatilità. Tutti gli elementi che rendono la seduta durevole - i contenuti, le schiume, le imbottiture - non sono mai visibili in primo piano. HAMMER racchiude tutte queste caratteristiche e, in aggiunta ad un elevato livello di confort, esprime una forte funzionalità grazie alle innumerevoli possibili configurazioni. Profondità di seduta e braccioli alti rendono HAMMER la soluzione ideale di seduta in ogni ambiente per ogni tipo di utilizzatore con le proprie abitudini.*

# HAMMER SOFT SEATING

HAMMER consists of a series of singular elements which can be easily combined and fixed together. Cubical elements recalling the typical shape of a brick. Made by an inner boxed multilayer frame with polyurethane padding in differentiated densities supported by interlaced high resistance elastic belts.

*HAMMER consiste in una serie di elementi singoli facilmente aggregabili e bloccabili tra loro. Elementi dalla forma cubica che ricordano la forma del mattone. Struttura interna «scatolata» in multistrato, imbottitura in poliuretano a densità differenziata supportata da cinghie elastiche intrecciate.*





# HAMMER SOFT SEATING



Elements are available in two different dimensions of width and in misaligned depth to allow any user to create his own configuration based on any space requirement. All elements of the range are supported by sled metal base or low anti-skid glides. HAMMER is also available in fire retardant version so to offer a 360° solution for the contract field as well.

*Gli elementi sono disponibili in due diverse larghezze ed in profondità non allineate per consentire ad ogni cliente di creare la propria configurazione a seconda degli spazi disponibili. Tutti gli elementi della collezione sono supportati da un basamento a slitta in metallo o in alternativa da semplici piedini in nylon anti-scivolo. mHAMMER è inoltre disponibile a richiesta nella versione ignifuga così da offrire una soluzione a 360° anche nelle applicazioni contract.*





# PALLET

LAYING DOWN ON A **PLATFORM.**





# PALLET SOFT SEATING



A modular sofa system inspired by traditional loading pallet, giving rise to the distinctive base detail. PALLET is a very generously proportioned and extremely comfortable low seating system with a wooden basement reminding a solid platform. Available in a wide range of configurations, with integrated storage and armrests. Produced from CMHR foam over a ply and hardwood basement with solid and veneered oak, this system allows countless of configurations.

*Sistema di sedute modulari ispirato dal tradizionale pallet di carico che evidenzia i dettagli dell'unicità dal basamenti. PALLET è un sistema di sedute basse, proporzionalmente generoso ed estremamente confortevole supportato da un basamento di legno che richiama la compattezza di una piattaforma. Disponibile in un'ampia varietà di configurazioni con compartimenti integrati e braccioli. Prodotto con schiume CMHR con basamento in legno massiccio di rovere questo sistema conta con innumerevoli configurazioni.*



Cubical seat, arms and backrest cushions contribute to build personal solutions according to the area of use. The essence of the system is represented by the platform supporting the cushions, symbolizing a pallet on top of which bricks are setting down. The entire system stands on the platform which is the base for the complementary range of the entire system.

*Sedute cubiche, braccioli e schienali contribuiscono a costruire soluzioni personali a seconda dell'area d'uso. L'essenza del sistema è rappresentata dalla piattaforma che sostiene le sedute, simbolizzando un Pallet sopra il quale vengono fissati svariati mattoni. L'intero sistema si sostiene sulla piattaforma che allo stesso tempo rappresenta la base degli elementi complementari dell'intera collezione.*





## PALLET SOFT SEATING

Pallet offers two platforms depth. The one flushed to backrest for compact areas suitable for contract use and more formal common decorations. More generous measurements for a deeper platform to decorate wider areas in a sort of back-shelving system for a homey perception. Straight lines, wooden feeling to fulfill sophisticated spaces.

*Pallet offre 2 profondità di piattaforma. Una base allineata con lo schienale di maggiore compattezza, adatta ad un uso contract e ad ambienti più formali. Una base con una profondità più generosa per arredare ampie aree con una sorta di pianale retro schienale di percezione più residenziale. Linee diritte e la calda sensazione del legno per arredare spazi non banali e sofisticati.*

## VENEER PLATFORM

Platform in multi-layered veneered in OAK and available in a wide range of finishes. These are thin layers sliced from solid wood of about 0.6 mm thick, glued onto lightweight boards and then covered with clear lacquer. A living material with a natural feel

## IRON PLATFORM

Platform in Metal is composed of horizontal beams in rectangular sections matt black painted and cylindrical legs matt black painted or chromed.

## PIATTAFORMA DI LEGNO

*Piattaforma in multistrato di legno Rovere disponibile in un'ampia gamma di finiture. Sottile lamine di legno massello dello spessore di 0.6 mm, incollate su tavole di portanti e rifinite con laccatura. Un materiale vivo dal tocco naturale.*

## PIATTAFORMA DI METALLO

*La piattaforma di metallo è composta da barre orizzontali in sezione rettangolare verniciate in color nero opaco e da piedini rotondi vernicati nero opaco o cromati.*





# PALLET SOFT SEATING

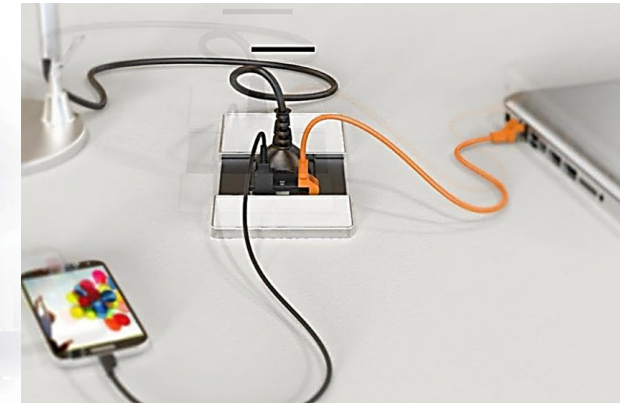



# SS007

SYSTEM OF **ELEGANT** LOW BACK SOFAS.





System of elegant low back sofas very much appreciated for the warm welcome it offers guests in waiting areas and also for informal meetings. The collection is a guarantee of elegance with its chrome details and nice comfort thanks to the particular cushioning which is also used for armrests.

This line has been designed to offer a wrap around feeling. The wide selection of finishings and colours, leather included, can have the product placed in any setting with sobriety.

*Sistema di eleganti sedute basse estremamente apprezzato per la calda accoglienza offerta all'utilizzatore in sale d'attesa e riunioni informali. La collezione è garanzia di eleganza con i suoi dettagli cromati e l'elevato confort grazie al sistema di cuscini utilizzato anche sui braccioli.*

*Questa gamma è stata disegnata per trasmettere una sensazione che avvolge completamente la persona. L'ampia scelta delle finiture e dei colori dei tessuti e delle pelli di rivestimento consente di disporre la seduta in ogni ambientazione con sobrietà.*





Sofas, modular elements, armchairs and benches with complementary coffee tables. This line has been designed to offer a wraparound feeling. The wide selection of finishing and colours, leather included, can have the product placed in any setting with sobriety.

*Divani, elementi modulari, poltrone e panche accompagnati da tavolini bassi. Questa linea è stata disegnata per garantire un feeling completamente avvolgente. L'ampia gamma delle finiture e dei colori, incluse le pelli, consentono alle sedute di essere esposte in ogni tipo di scenografia con estrema sobrietà.*







# SS010





System of individual seating elements with a distinctive identity. Single, double and three seaters, the line has been designed to offer as an executive seating range for high quality reception and lounge areas. Its style is emphasized by the simple but elegant leg supports emphasising the formal design of the range.

*Sistema di elementi di seduta individuali con forte identità. Poltrona, due posti e tre posti, la linea è stata disegnata per rispondere alle esigenze di un prodotto adatto ad aree direzionali e di reception così come di ampia attesa. Il suo stile è enfatizzato dai semplici ed allo stesso tempo eleganti supporti che evidenziano il design formale della gamma.*



The chromed details contribute to highlight the overall aesthetic. The wide selection of finishing and colours, leather included, can have the product placed in any setting with sobriety. Although its generous dimensions, the system can be used equally in any small or big area due to its compacted construction shape.

*I dettagli cromati contribuiscono ad evidenziare l'estetica delle sedute. L'ampia gamma delle finiture e dei colori, incluse le pelli, consentono alle sedute di essere esposte in ogni tipo di scenografia con estrema sobrietà. Nonostante le dimensioni abbondanti, il sistema si adatta ad essere utilizzato indistintamente in aree di piccole e grandi dimensioni grazie alla compatta forma di fabbricazione.*



# SS012

A **STRONG** EMBRACING **IDENTITY.**







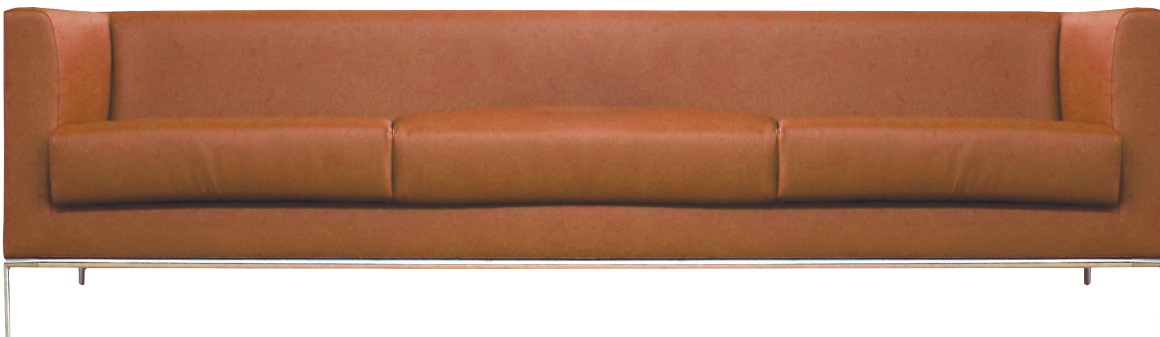

System of sofas with a strong embracing identity. Armchairs, sofas in different sizes designed to offer as an executive seating range for high quality receptions, lounge areas and private offices. Its style is emphasized by the all-around tubular aluminium frame and the elegant and stylish aluminium legs. The balanced proportions are assuring a comfortable and long lasting sitting.

*Sistema di elementi di seduta con un'identità avvolgente. Poltrona e divanetti in diverse dimensioni disegnati per offrire una risposta di sedute direzionali per zone di attesa di alto livello, aree lounge ed uffici privati. Il suo stile è enfatizzato dal disegno continuo del basamento in tubo circolare di alluminio e dagli eleganti supporti sempre in alluminio. Le proporzioni bilanciate assicurano un confort di seduta di lunga durata.*







The polished chromed details of the aluminum frame embellish the aesthetic of the range. The wide selection of finishing and colours, leather included, can have the product placed in any setting with sobriety.

Although its generous dimensions, the system can be used equally in any small or big area due to its compacted cubical construction shape.

*I dettagli lucidi del basamento in alluminio sottolineano la bellezza dell'estetica della gamma. L'ampia gamma delle finiture e dei colori, incluse le pelli, consentono alle sedute di essere esposte in ogni tipo di scenografia con estrema sobrietà.*

*Nonostante le dimensioni abbondanti, il sistema si adatta ad essere utilizzato indistintamente in aree di piccole e grandi dimensioni grazie alla compatta forma di fabbricazione.*







# SS016

**BOXED** ARMCHAIR AND SOFAS.





Range of armchair and sofas with a distinctive “boxed” design. Simple, elegant and inviting, the system can be placed in corporate or hospitality environments to create sumptuous dining, lounge, reception or breakout areas. The family includes sofas and armchair which share the same simple proportions and deep level comfort thanks to the rear falling seat design.

*Gamma di poltrone e sedute dall'evidente design cubico. Semplice, elegante ed invitante, il sistema può essere utilizzato indifferentemente in ambienti corporativi o di ospitalità per creare magnifiche aree dining, di reception e di ricreazione. La gamma include divanetti e poltrone che si caratterizzano per le semplici proporzioni e per l'importante livello di confort grazie anche al disegno inclinato delle sedute.*





*La costruzione in un unico blocco, utilizzata nella seduta e nello schienale, comunica all'utilizzatore un senso di seduta avvolgente senza comprometterne il confort. La versione con schienale livellato si accompagna a quella con schienale più alto. Gambe cilindriche supportano l'intera struttura mentre l'ampia gamma delle finiture e dei colori, incluse le pelli, consentono alle sedute di essere esposte in ogni tipo di scenografia con estrema sobrietà.*





The all-in-one construction applied to seat and back gives the user a sense of space from adjoining chairs, without compromising on comfort. A levelled back version is accompanied by a higher back version. Cylindrical legs are supporting the all structure. The wide selection of finishing and colours, leather included, can have the product placed in any setting with sobriety.





# SS022

**SOFAS** WITH A DISTINCTIVE  
**EXECUTIVE IDENTITY.**





System of sofas with a distinctive executive identity. Armchairs, sofas in different sizes designed to offer as an executive seating range for high quality receptions, lounge areas and private offices. The collection is a guarantee of elegance with its chrome details and nice comfort. The balance between seat and back cushioning is assuring a comfortable and long lasting sitting.

*Sistema di sedute con una chiara identità direzionale. Poltrone e divanetti in differenti misure disegnati quali sedute di livello per aree di reception, lounge ed uffici privati. La collezione è una garanzia di eleganza grazie ai suoi dettagli di cromature ed al perfetto confort. L'equilibrio tra i cuscini di seduta e schienale garantisce un confort di lunga durata.*



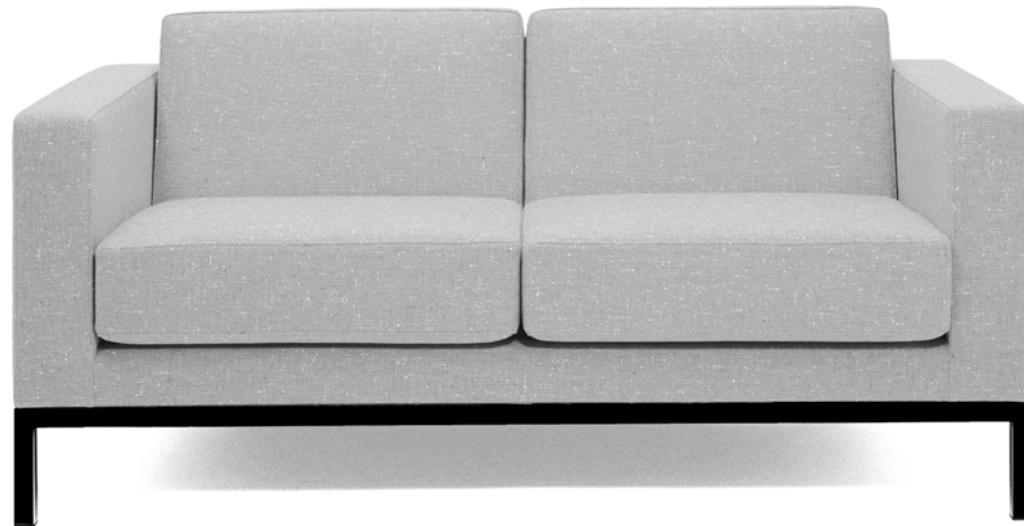

The chromed details of the frame embellish the aesthetic of the range. The wide selection of finishing and colours, leather included, can have the product placed in any setting with sobriety. Although its generous dimensions, the system can be used equally in any small or big area due to its compacted cubical construction shape.

*I dettagli cromati della struttura impreziosiscono l'estetica della gamma. L'ampia gamma delle finiture e dei colori, incluse le pelli, consentono alle sedute di essere esposte in ogni tipo di scenografia con estrema sobrietà. Nonostante le dimensioni abbondanti, il sistema si adatta ad essere utilizzato indistintamente in aree di piccole e grandi dimensioni grazie alla compatta forma di fabbricazione.*



Moreover, the collection offers a range of single seater armchairs of a more casual look, supported by metal bases allowing wider possibilities of use of the entire collection. In addition, a second option of sofa base with higher visible metal sides giving a «wrapping» feeling and a more industrial design look is also available.

*La collezione offre inoltre una serie di sedute singole d'attesa più informali supportate da basamenti metallici che diversificano ed ampliano le possibilità di utilizzo dell'intera linea. In aggiunta, su tutta la linea, vi è una seconda opzione di basamento con laterali a vista che «racchiudono» l'estetica dell'intero divano dandone un'apparenza ancor più industriale.*







# BREAKOUT & CHAIR



# 8CUBE





The 8CUBE collection is a range of crafted ottomans and benches offering flexible seating for any space. Whether disordered in multiple configurations or combined with other products, 8CUBE contributes to fill up areas increasing the number of usable informal seating. Cubical and round forms to be specified as complement to tables, lounge and breakout spaces for younger users as well.

The essence of the system is represented by the idea of the spotty configuration. Simple, robust, proportional and beautifully crafted units that can be covered in an extensive choice of fabrics and leathers.

*La collezione 8CUBE è una gamma di pouff e panche di realizzazione artigianale che offre un'estrema flessibilità per ogni spazio di accoglienza. Disordinati in configurazione multiple o combinati con altri prodotti, 8CUBE contribuiscono a colmare gli spazi aumentando il numero di sedute informali. Forme cubiche e tondeggianti, abbinata a tavoli e tavolini, ideali per lounge e spazi svago anche per giovani operatori.*

*L'essenza del sistema è rappresentato dall'idea della configurazione a macchia. Semplici, robusti, proporzionali e curatamente rifiniti, questi elementi possono essere rivestiti in un'ampia scelta di tessuti e pelli.*



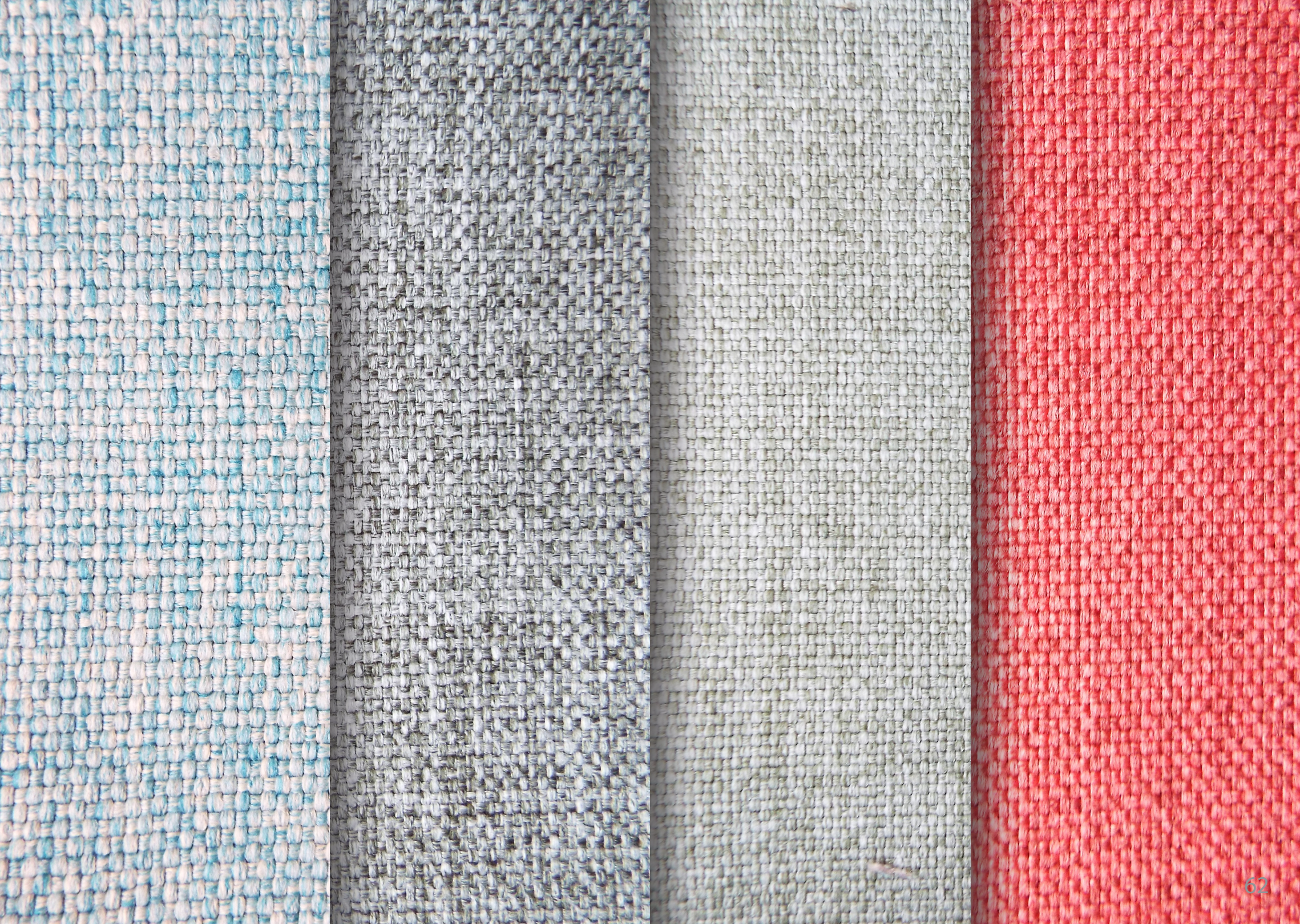

# SS031, SS032, SS036







# SS031, SS032, SS036 BREAKOUT&CHAIR

A combination of style and versatility, this family of modern breakout chairs perfectly fits the demand of workplace, open sitting areas, foyer, meeting rooms and hospitality environments. The wide range of base frames allows the chairs for a multi-functional use.

*Eleganti e versatili, questa famiglia di sedute dall'estetica moderna è la perfetta risposta alle domande degli ambienti di lavoro, spazi d'ingresso, aree ricreazione, sale riunioni and aree ho.re.ca. L'ampia gamma di basi rende le sedute adatte ad un utilizzo multifunzionale.*





# SS033



SS033 is a popular choice of breakout chair. The casual but formal design offers a superb level of comfort and is ideal for third space, foyer, breakout locations as well as meeting rooms and hospitality environments.

*SS033 rappresenta una scelta tipica di seduta da ricreazione. La sua forma casual e allo stesso tempo formale garantisce un alto livello di confort ideale per sale d'ingresso, aree ricreazione, sale riunioni and ambienti ho.re.ca in generale.*





SS033's open backrest design creates modern aesthetic whilst the refined seams highlight the allaround curved profile of the range bearing the hallmark of Spaceform Design. The collection consists of a wide range of base frames that allows the chair for a multi-functional use.

*Il particolare disegno dello schienale aperto crea un'estetica moderna mentre le rifinite cuciture ne evidenziano il curvilineo profilo rimarcando l'impronta del design Spaceform. La collezione offre un'ampia gamma di basi che rendono la seduta adatta ad un utilizzo multifunzionale.*



# SS034



SS230 is an elegant choice of breakout chair of a contemporary inspiration. The formal and sinuous design offers a superb level of comfort and is ideal for elegant areas such as restaurants, foyer, domestic areas as well as formal meeting rooms and refined environments.

A warm touch is also given by the wooden rounded four legs available in a choice of several finishes to meet all kind of environments. The refined seams highlight the curved profile of the seat bearing the hallmark of Spaceform Design.

*SS230 rappresenta una scelta di seduta elegante di ispirazione contemporanea. Il suo disegno formale e sinuoso offre un elevato livello di confort rendendola ideale per l'uso in eleganti spazi quali ristoranti, sale d'ingresso, aree domestiche così come sale riunioni formali ed ambienti raffinati.*

*Un tocco di calore è inoltre aggiunto dall'uso di una struttura a quattro gambe di legno disponibile in svariate finiture assicurandone il perfetto uso per qualsiasi tipo di ambiente. Le cuciture raffinate evidenziano il profilo della seduta rimarcando ancora l'impronta del design Spaceform.*





SS283 is an elegant choice of breakout chair of a contemporary inspiration. The formal and sinuous design offers a superb level of comfort and is ideal for elegant areas such as restaurants, foyer, domestic areas as well as formal meeting rooms and refined environments.

A warm touch is also given by the wooden four legs available in a choice of several finishes to meet all kind of environments. As alternative, four metal legs of the same design chromed finished are also available.

*SS283 rappresenta una scelta di seduta elegante di ispirazione contemporanea. Il suo disegno formale e sinuoso offre un elevato livello di confort rendendola ideale per l'uso in eleganti spazi quali ristoranti, sale d'ingresso, aree domestiche così come sale riunioni formali ed ambienti raffinati.*

*Un tocco di calore è inoltre aggiunto dall'uso di una struttura a quattro gambe di legno disponibile in svariate finiture assicurandone il perfetto uso per qualsiasi tipo di ambiente. In alternativa, gambe in metallo dello stesso design in finitura cromata.*





# SS035



SS035 is a range of Stylish armchair, perfect for working environment as well as hospitality: offices, meeting rooms, waiting rooms and hotels.

The wide range of bases that allows the chair to be multi-functional completing the range in its offer to communities and hospitalities areas.

*SS035 è una gamma di sedute formali ed eleganti perfetta per li ambienti di lavoro e per la collettività: uffici, sale riunioni, sale d'attesa ed hotels.*

*La vasta gamma di basamenti utilizzabili ne garantisce un uso multifunzionale completando la gamma nella sua offerta per comunità ed aree ricreative.*

SS035's linear shape creates modern design aesthetic and, at the same time, highlights the formal profile of the range bearing the hallmark of Spaceform Design.

*La linearità del suo disegno crea un'estetica moderna e contestualmente evidenzia il profilo formale della gamma rimarcando l'impronta del design Spaceform.*



## SS035 BREAKOUT&CHAIR

SS035 is a combination of style and versatility, a family of multi-purpose chairs. Perfectly fitting the demand of the modern workplace and open sitting areas, the range is suitable for breakout areas, dining areas, meeting rooms and hospitality environments.

*SS035 è una combinazione di stile e versatilità, un famiglia di sedute multifunzionale. Perfetta risposta alle domande degli ambienti di lavoro moderni e degli spazi aperti, la gamma si adatta alle aree di ricreazione, sale pranzo, sale riunioni e spazi ho.re.ca.*



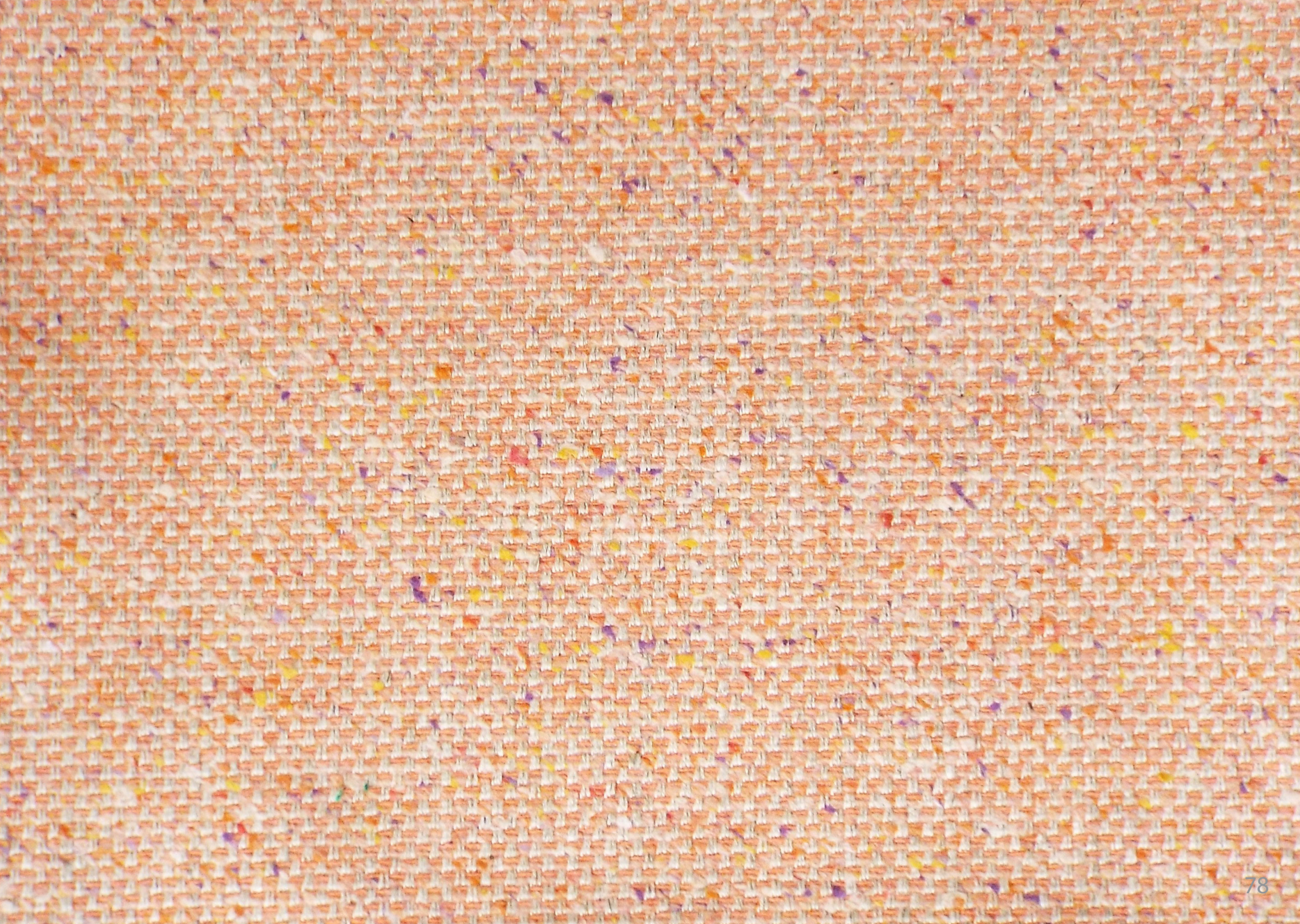

SS037



SS037 is a new breakout chair ideal for workplace areas. Its unmarked profile makes it perfect for those who like a seating unit not to be bulky within the spaces. Thanks to the inner solid steel structure, the chair is suitable for any kind of use in the workplace. In addition, an insert of rigid polyurethane allows the seat to be extremely comfortable during the time.

*SS037 è una nuova seduta collettività ideale per gli spazi di lavoro. Il suo design pulito la rende perfetta per coloro che desiderano un prodotto poco invadente e quasi inosservato nell'arredo degli spazi. Grazie all'anima interna di acciaio, SS037 è adatta ad ogni tipo di uso nelle aree di lavoro. In aggiunta, l'insero in poliuretano rigido del sedile, la rende estremamente confortevole durante tutto il tempo di utilizzo.*





SS037, as well as all other Spaceform breakout products, can be equipped with a wide range of bases, from castors to fixed star base, from spider to more classic round base allowing the chair to a multi-functional use.

*SS037, cos' come tutti gli altri prodotti Spaceform di collettività, può essere realizzata con un'ampia scelta di basi, dalla base con ruote a quella fissa a quattro razze, dalla base a ragno a quella più usualmente utilizzata a disco marcandone la specificità di prodotto multi funzionale.*





# SS038

RANGE OF **ARMCHAIRS**  
FOR **MEETING** AND **WAITING** AREAS



SS038 is a range of armchairs for meeting and waiting areas in different designs but same construction process: steel structure filled with cold-molded polyurethane foams.

All types of design offer superb levels of comfort and are ideal for formal space, waiting areas, breakout locations as well as meeting rooms and hospitality environments.

All designs can be equipped equally with floor anti-skid glides or castors.

*SS038 è una gamma di poltroncine per riunioni e sale d'attesa con diversi design ed in comune lo stesso metodo produttivo: realizzati con struttura in acciaio e resine poliuretatiche iniettate a freddo.*

*Tutti i tipi di design offrono un elevato confort e sono ideali per spazi formali, sale d'attesa, zone ricreazione così come per sale riunioni ed spazi collettivi.*

*Ogni modello può essere fornito indifferentemente con piedini anti scivolo o con ruote.*





SS038 is a range of armchairs for meeting and waiting areas in different designs but same construction process: steel structure filled with cold-molded polyurethane foams. All types of design offer superb levels of comfort and are ideal for formal space, waiting areas, breakout locations as well as meeting rooms and hospitality environments. All designs can be equipped equally with floor anti-skid glides or castors.

*SS038 è una gamma di poltroncine per riunioni e sale d'attesa con diversi design ed in comune lo stesso metodo produttivo: realizzati con struttura in acciaio e resine poliuretatiche iniettate a freddo. Tutti i tipi di design offrono un elevato confort e sono ideali per spazi formali, sale d'attesa, zone ricreazione così come per sale riunioni ed spazi collettivi. Ogni modello può essere fornito indifferentemente con piedini anti scivolo o con ruote.*



# SS040

ARMCHAIRS WITH A **SLIM DESIGN** PROFILE



## SS040 BREAKOUT&CHAIR



SS040 is a range of armchairs distinguished by a slim design profile. Thanks to the inner solid steel structure, the range is suitable for any kind of use in the workplace. SS040 includes a low and a high back version as well as a typical tub chair materializing the range into a perfect multi-functional product.

*SS040 è una gamma di sedute caratterizzata da un design minimale. Grazie all'anima interna di acciaio, la gamma è adatta ad ogni tipo di uso nelle aree di lavoro. SS040 include versioni a schienale basso ed alto nonché una tipica seduta a pozzetto completando la gamma quale prodotto multi funzionale.*





Its slim unmarked profile makes it perfect for those who like a seating unit not to be bulky within the spaces offering at the same time a superb level of comfort and is ideal for third space, foyer, breakout locations as well as meeting rooms and hospitality environments.

*Il suo design pulito la rende perfetta per coloro che desiderano un prodotto poco invadente e quasi inosservato nell'arredo degli spazi garantendo allo stesso tempo un alto livello di confort ideale per sale d'ingresso, aree ricreazione, sale riunioni and ambienti ho.re.ca in generale.*



## SS040 BREAKOUT&CHAIR

A wide selection of bases includes a simple four legs version, star bases fixed and on castors, round discs, cantilever and a beech wood four leg frame. Simply a complete multi-functional product.

*L'ampia gamma di opzioni di basi di supporto include strutture a quattro gambe, basi a razze fisse e con ruote, piatti tondi, slitte nonché la versione quattro gambe in legno di faggio. Semplicemente una gamma completa di sedute multi-funzione.*







# SS042

LOUNGE CHAIRS IDEAL FOR WAITING  
AREAS AND **BREAKOUT**



All designs offer a superb levels of comfort. Designed in-house, the range incorporates contemporary touches that make every design suitable for today's hospitality and boutique hotel environment, and even the corporate arena. The generous dimensions make them suitable for relaxing areas, granting at the same time a comfortable seating feeling.

*Tutte le versioni offrono un elevato livello di confort. Disegnata internamente, the gamma incorpora impronte contemporanee rendendola utilizzabile in svariati settori di collettività, boutique hotels e ambienti corporativi. Le abbondanti dimensioni delle sedute le rendono perfettamente compiacenti in area di relax garantendo una sensazione di seduta di estremo confort.*



A masculine feeling of well-defined lines for a all-embraced lounge solution. Designed to sit amiably alongside these and other furnishings, the chairs may be used as a stand-alone piece to make a bold design statement. The collection consists of a wide range of base frames that allow the chairs to a multi-functional use.

*Sensazioni di linee ben definite per soluzioni di sedute accoglienti. Disegnate per essere abbinare con altri arredi, le sedute possono essere utilizzate anche come oggetti individuali di arredo. La collezione offre un'ampia gamma di basi che rendono la seduta adatta ad un utilizzo multifunzionale.*



SS042 is a range of lounge chairs ideal for waiting areas and breakout. Different options of design but same construction process: steel structure filled with cold-molded polyurethane foams.

*SS042 è una gamma di ampie sedute adatte ad aree d'attesa e di ricreazione. Differenti soluzioni di design accomunate dallo stesso processo di fabbricazione: strutture in acciaio annegate in resine poliuretatiche iniettate a freddo.*







# OFFICE



# PAK Chair

A **FULL MESH** OFFICE CHAIR





The Pak Chair is a swivel office chair type with very comfortable seating for workstations, meeting and executive areas as well as for reception in the front office. Pak Chair is the perfect tool for the daily work, embracing total functionality with design.

*La Pak Chair è una seduta da ufficio girevole con un alto confort di seduta adatta per posti di lavoro, aree riunioni e direzionali così come per aree di reception. Pak Chair è lo strumento perfetto per il lavoro quotidiano che racchiude allo stesso tempo funzionalità e design.*



## THE PERFECT FIT

Featuring adjustable seat depth, counterbalancing mechanism, integrated snap lock lumbar support, comfortable armrests adjustable in 3 axis and the optional functional headrest, the PAK Chair fits perfectly the highest standards of ergonomic and solidity.

## LA MISURA PERFETTA

*Equipaggia con regolazione di profondità seduta, meccanismo controbilanciante, regolazione integrata del supporto lombare, braccioli regolabili su 3 dimensioni e un poggiatesta opzionale regolabile, la Pak Chair soddisfa perfettamente i più alti standard ergonomici e di solidità.*



HEADREST

ARM ANGLE

HEIGH & DEPTH

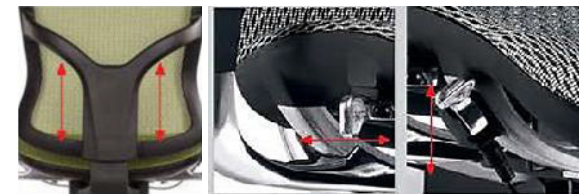

SNAP SUPPORT

SLIDING SEAT

MULTILOCK

# THE HIGHEST IN FUNCTIONALITY

**ALWAYS IN BALANCE**

Wellbeing and work performance are closely related. Our ability to pursue the best designs has always gone hand in hand with specific ergonomic designs. The PAK Chair always provides a dedicated relaxing and unwinding experience, for liaising and regaining a sense of mental and physical balance. PAK Chair is the right balance between harmonious silhouettes that safeguard the right posture, functionalities and design appreciating a satisfactory timework.

**EQUILIBRIO COSTANTE**

*Benessere e performance sul lavoro sono strettamente correlati. La nostra capacità di perseguire il miglior design è sempre andata pari passo con le specifiche di ergonomia. La Pak Chair offre sempre un'esperienza di relax e distensione per recuperare e curare il senso mentale e fisico dell'equilibrio.*

*Pak Chair è il giusto equilibrio di forme armoniose che salvaguardano le giuste posture, di funzionalità e design, facendo apprezzare il tempo dedicato al lavoro.*



CAST **ALUMINUM** CHASSIS  
COUNTERBALANCING **MECHANISM**

## BREATHABLE COLORED FLEXIBILITY

The PAK Chair features the highest in TRANSPARATION thanks to its mesh seat and back construction.

In addition PAK Chair matches the current trends in office interiors as it comes in a variety of mesh colors to underline the sense of comfort. Mesh can be selected between 2 different patterns. Please request our material swatches for your selection.

## FLESSIBILITA' COLORATA E TRASPIRANTE

*La Pak Chair rappresenta il massimo della TRASPIRAZIONE grazie alla seduta ed al suo schienale costruiti in Rete.*

*In aggiunta, la Pak Chair risponde ai requisiti più moderni nell'arredo ufficio dato che è disponibile n un'ampia varietà di colori che ne sottolineano il confort. Le reti possono essere scelte fra 2 tipologie di trama. Richiedete i nostri campioni di materiali per la Vostra scelta.*





# PAK CHAIR OFFICE



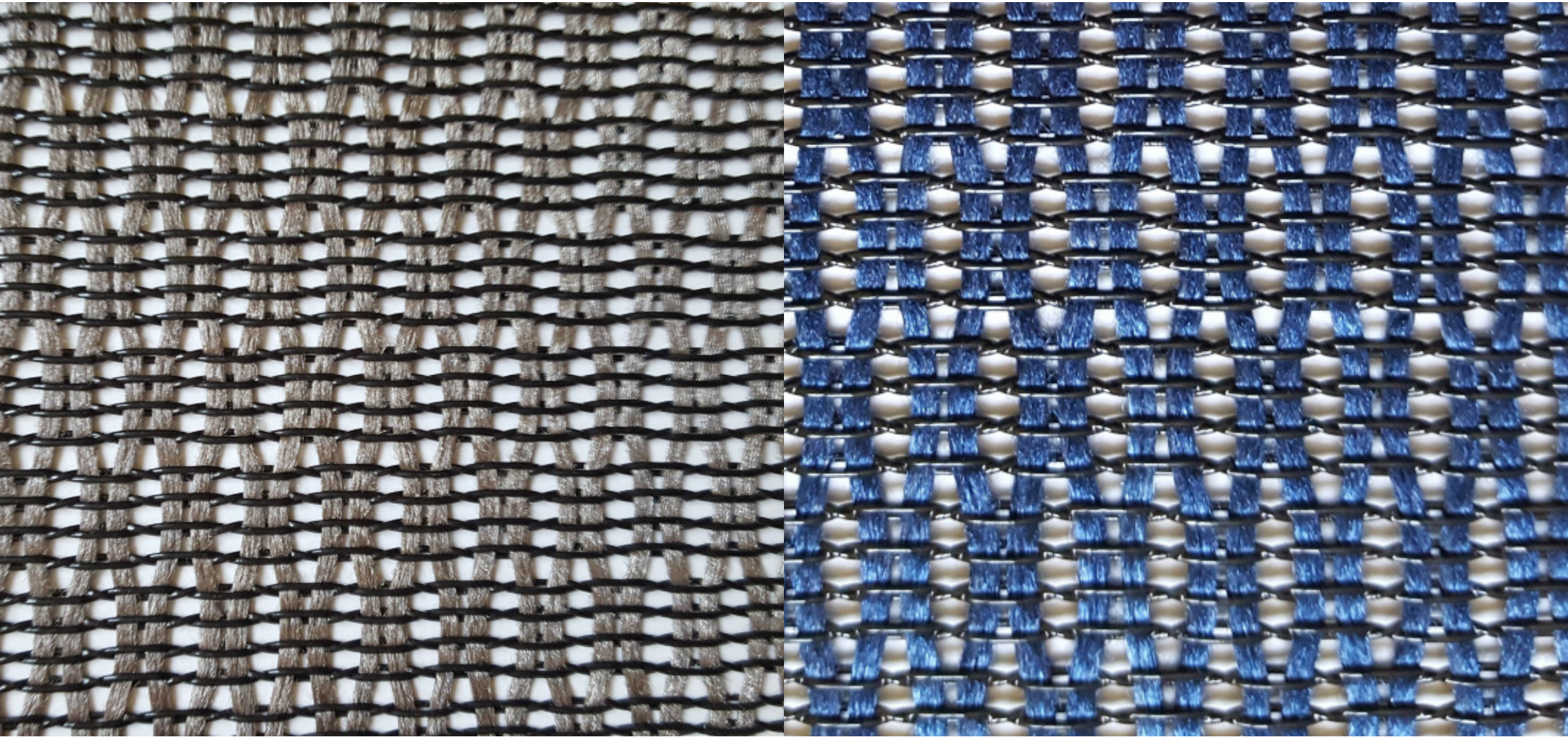

# MIR Chair

CAST ALUMINUM CHASSIS



## SIT IN COMFORT THROUGHOUT THE DAY

The last thing you want to worry about at work is the chair you are sitting on. Thanks to its CAST ALUMINUM framework and arms supports, MiR with its clean outline, solid structure, ergonomic design and wonderful color options, blends into any modern office environment for a peace of mind.

## CONFORT DI SEDUTA CONTINUA

*L'ultimopensiero di cui vogliate preoccuparvi al lavoro è la vostra seduta. Grazie alla sua scocca portante ed ai supporti braccioli in FUSIONE DI ALLUMINIO, la MIR con le sue linee pulite, la sua solida struttura, il design ergonomico ed i suoi colori rappresenta la perfetta fusione con ogni tipo di ambiente moderno d'ufficio.*



## ALWAYS IN BALANCE

The MiR office chair feels immediately comfortable due to its ergonomic support of your lower back. No matter how you sit, upright or reclined, the backrest gives you support proportional to your body's need. The backrest comes in two variants, upholstered or with a mesh with a rich selection of colors to fit your interior.

## EQUILIBRIO COSTANTE

*La MIR offre un'immediata sensazione di confort grazie al supporto ergonomico della schiena dell'utilizzatore. Non importa come vi sediate, eretti o reclinati, lo schienale da immediatamente supporto in proporzione alla richiesta del corpo.*

*Lo schienale è disponibile in due versioni, rivestito o in rete con un'ampia selezione di colori per soddisfare ogni tipo di arredo.*



## THE PERFECT FIT

With an adjustable seat depth, automatic balancing of the lower back support and comfortable arm rests adjustable in 3 axis, the MiR office chair fits perfectly and feels comfortable from the first moment. The seat height can be easily set between 45cm and 54cm to fit everyone's need.

## LA MISURA PERFETTA

*Equipaggia con regolazione di profondità seduta, meccanismo auto-bilanciante, braccioli regolabili su 3 dimensioni, la Mir soddisfa perfettamente i più alti standard ergonomici e di solidità.*

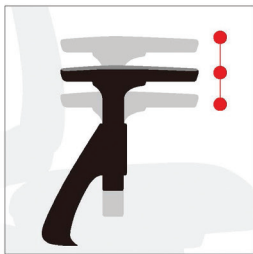

HEIGHT

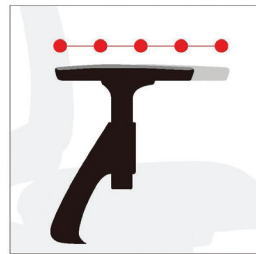

DEPTH

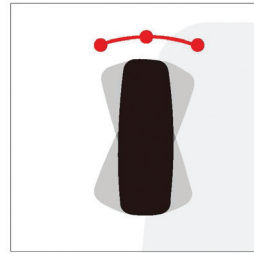

PIVOT



# MIR CHAIR OFFICE







# MIR3 Chair

MULTI FUNCTIONAL



## COMFORTABLE OFFICE CHAIR FAMILY

The MiR3 product family gives you all options to refurbish your modern office. It combines clean lines with outstanding comfort and quality.

## SYNCHRONIZED MOVEMENT

The synchro-tilt mechanism and the proper location of pivot points make Mir3 movement match or mirror the natural body movements of the chair user.

## UNA FAMIGLIA DI SEDUTE CONFORTEVOLI

*La linea MiR3 offre tutte le soluzioni per arredare un ufficio moderno. Combina linee pulite con un elevato confort e un'ottima qualità*

## EQUILIBRIO COSTANTE

*Il meccanismo sincronizzato ed il corretto posizionamento dei punti pivot rendono il movimento della MiR3 perfettamente in sintonia con il movimento naturale del corpo del suo utilizzatore.*



## MULTI-FUNCTIONAL ARMS

The MiR3 arms are easily adjusted in height, depth and width to accommodate each user's tasks and preferences.

## BRACCIOLI MULTI-FUNZIONALI

*I braccioli della MiR3 sono facilmente regolabili in altezza, in profondità ed in larghezza al fine di adattarsi alle preferenze ed esigenze del suo utilizzatore.*

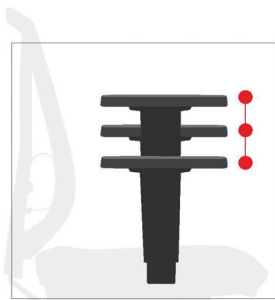

HEIGHT

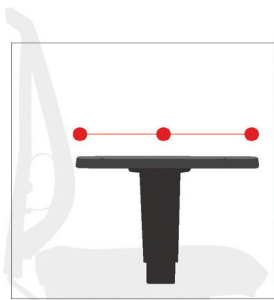

DEPTH

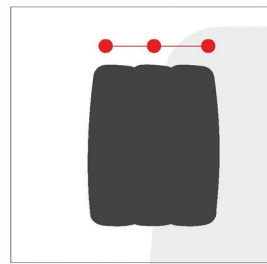

WIDTH



# MIR3 CHAIR OFFICE



... GIVE US **IDEAS**  
WE MAKE THEM **HAPPEN.**

# OVERVIEW & DIMENSIONS



## BASE

Seating elements are sustained by full depth sled steel base with a flat thin design of 50mm thickness, chromed or black powder coated. Alternatively, by low anti-skid glides in black Nylon.

## UPHOLSTERY

HAMMER can be upholstered in a wide range of contract fabrics, eco-leathers and genuine leathers from Spaceform's standard upholstery collection. Customer's Own material – fabrics and leathers – are applicable subject to Spaceform's approval after testing the submitted samples.

## BASAMENTO

*Gli elementi sono sostenuti da basi a slitta in metallo a profondità intera dal profilo sottile di spessore 50mm, cromate or verniciate a polveri. In alternativa si possono usare dei piedini bassi in Nylon nero.*

## RIVESTIMENTI

*HAMMER può essere rivestito in un'ampia gamma di tessuti contract, in eco-pelli e pelli naturali della collezione di rivestimenti Spaceform. L'uso di materiali cliente – tessuti o pelli – è consentito previo approvazione di Spaceform dopo aver testato i relativi campioni.*

## STANDARD MODULES

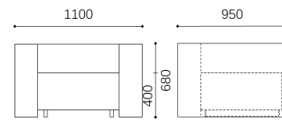

SS.HMR.1S - Sofa 1 seater

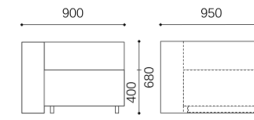

SS.HMR.E1 - End Element R/L

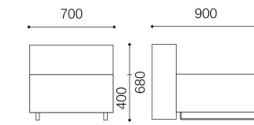

SS.HMR.C1 - Central Element

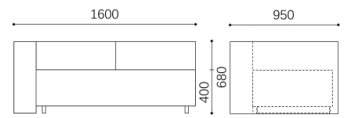

SS.HMR.E2 - End el. 2 seater R/L

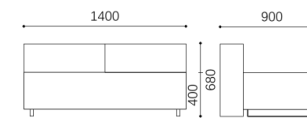

SS.HMR.C2 - Central El. 2 seater

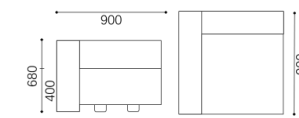

SS.HMR.CE - Corner Element

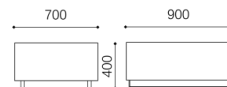

SS.HMR.P1 - Ottoman 1 seater

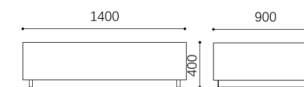

SS.HMR.P2 - Ottoman 2 seater

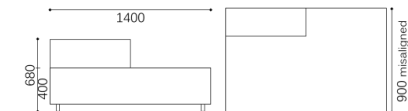

SS.HMR.I2 - Island El. Misaligned R/L

## LARGE MODULES

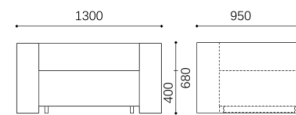

SS.HML.1S - Sofa 1 seater

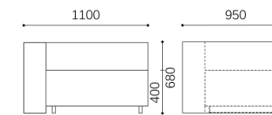

SS.HML.E1 - End Element

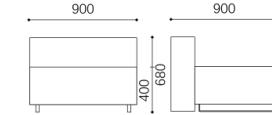

SS.HML.C1 - Central Element

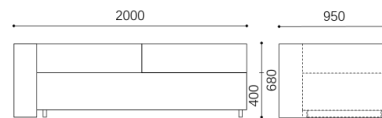

SS.HML.E2 - End el. 2 seater

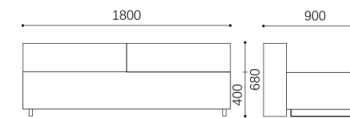

SS.HML.C2 - Central El. 2 seater

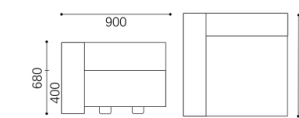

SS.HML.CE - Corner Element

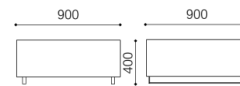

SS.HML.P1 - Ottoman 1 seater

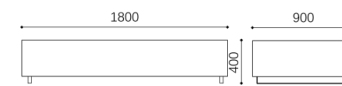

SS.HML.P2 - Ottoman 2 seater

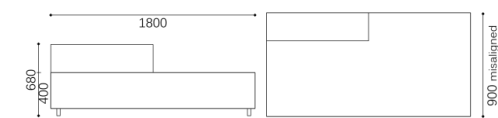

SS.HML.I2 - Island El. Misaligned



## VENEER PLATFORM

Platform in multi-layered veneered in OAK and available in a wide range of finishes. These are thin layers sliced from solid wood of about 0.6 mm thick, glued onto lightweight boards and then covered with clear lacquer. A living material with a natural feel.

## IRON PLATFORM

Platform in Metal is composed of horizontal beams in rectangular sections matt black painted and cylindrical legs matt black painted or chromed.

## UPHOLSTERY

PALLET can be upholstered in a wide range of contract fabrics and eco-leathers and leathers from Spaceform's standard upholstery collection. Customer's Own material – fabrics and leathers – are applicable subject to Spaceform approval after testing the submitted samples.

## PIATTAFORMA DI LEGNO

*Piattaforma in multistrato di legno Rovere disponibile in un'ampia gamma di finiture. Sottile lamine di legno massello dello spessore di 0.6 mm, incollate su tavole di portanti e rifinite con laccatura. Un materiale vivo dal tocco naturale.*

## PIATTAFORMA DI METALLO

*La piattaforma di metallo è composta da barre orizzontali in sezione rettangolare verniciate in color nero opaco e da piedini rotondi verniciati nero opaco o cromati.*

## RIVESTIMENTI

*PALLET può essere rivestito in un'ampia gamma di tessuti contract, in eco-pelli e pelli naturali della collezione di rivestimenti Spaceform.*

*L'uso di materiali cliente – tessuti o pelli – è consentito previo approvazione di Spaceform dopo aver testato i relativi campioni.*

## WOODEN PLATFORM

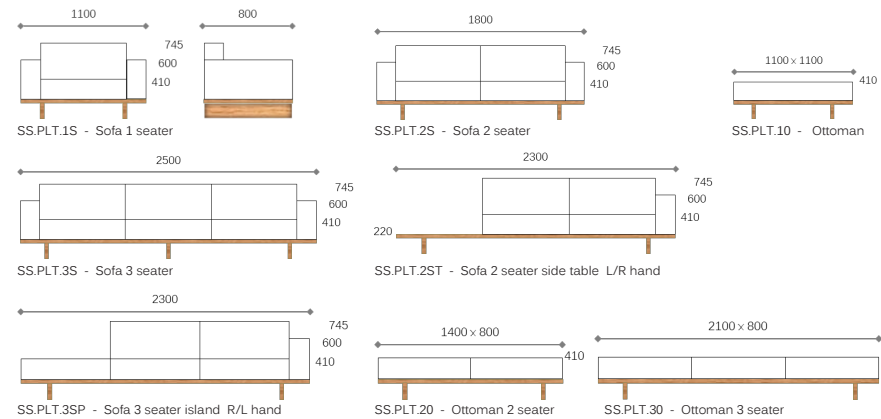

## IRON PLATFORM

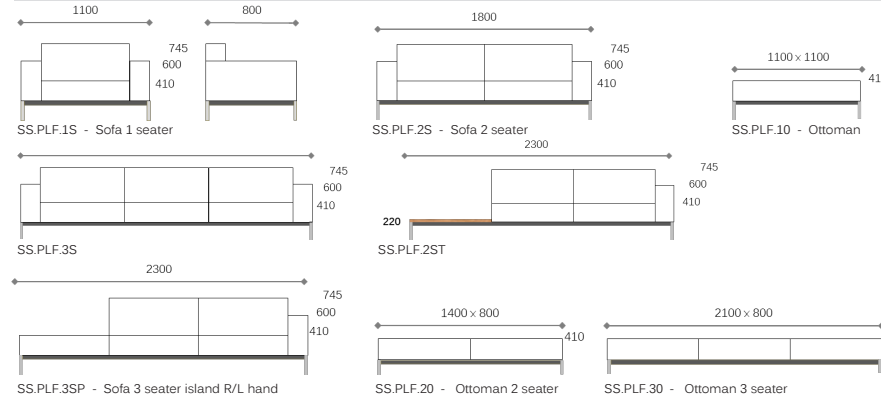

## LARGE WOODEN PLATFORM

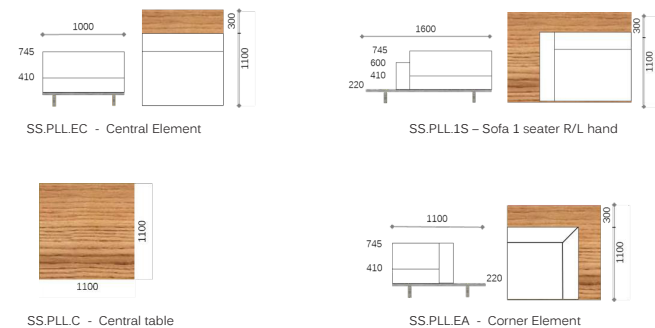





## BASE

Seating elements are sustained by full depth sled steel base with a flat thin design of 50mm thickness, chromed or black powder coated. Alternatively, by low anti-skid glides in black Nylon

## UPHOLSTERY

SS007 can be upholstered in a wide range of contract fabrics, eco-leathers and genuine leathers from Spaceform's standard upholstery collection. Customer's Own material – fabrics and leathers – are applicable subject to Spaceform's approval after testing the submitted samples.

## BASAMENTO

*Gli elementi sono sostenuti da basi a slitta in metallo a profondità intera dal profilo sottile di spessore 50mm, cromate o verniate a polveri. In alternativa si possono usare dei piedini bassi in Nylon nero.*

## RIVESTIMENTI

*SS007 può essere rivestito in un'ampia gamma di tessuti contract, in eco-pelli e pelli naturali della collezione di rivestimenti Spaceform.*

*L'uso di materiali cliente – tessuti o pelli – è consentito previo approvazione di Spaceform dopo aver testato i relativi campioni.*

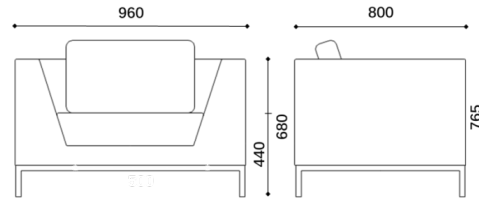

SS.007.1S - Armchair

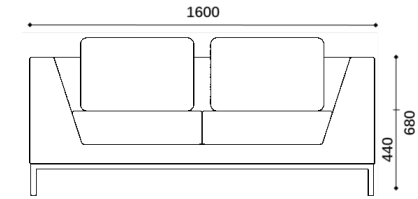

SS.007.2S - Sofa 2 seater

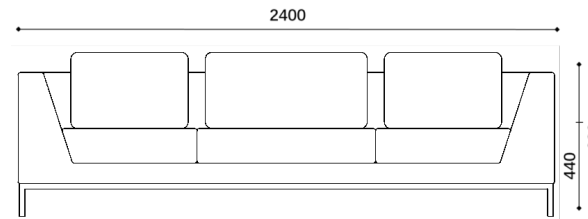

SS.007.3S - Sofa 3 seater

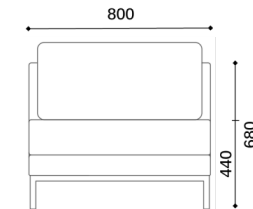

SS.007.1P - Single element

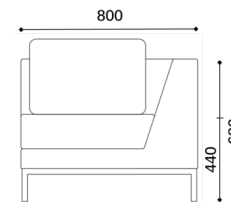

SS.007.1C - Corner element

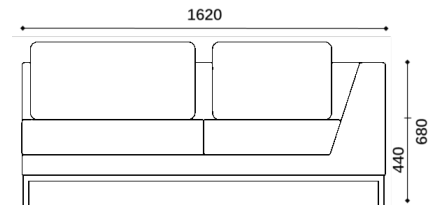

SS.007.2P.L-R - 2 seater element R/L hand

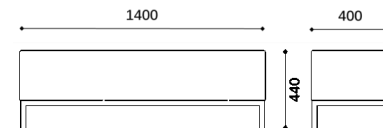

SS.007.PR - Rectangular bench

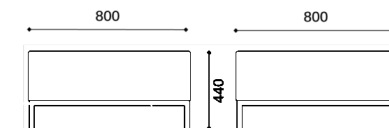

SS.007.PQ - Square bench



## BASE

Square tubular Steel frame finished with epoxy powder coating or chromed.

## UPHOLSTERY

SS010 can be upholstered in a wide range of contract fabrics, eco-leathers and genuine leathers from Spaceform's standard upholstery collection. Customer's Own material – fabrics and leathers – are applicable subject to Spaceform's approval after testing the submitted samples.

## BASAMENTO

Base in tubo metallo sezione quadrata, verniciata a polveri epossidiche o cromato.

## RIVESTIMENTI

SS010 può essere rivestito in un'ampia gamma di tessuti contract, in eco-pelli e pelli naturali della collezione di rivestimenti Spaceform. L'uso di materiali cliente – tessuti o pelli – è consentito previo approvazione di Spaceform dopo aver testato i relativi campioni.

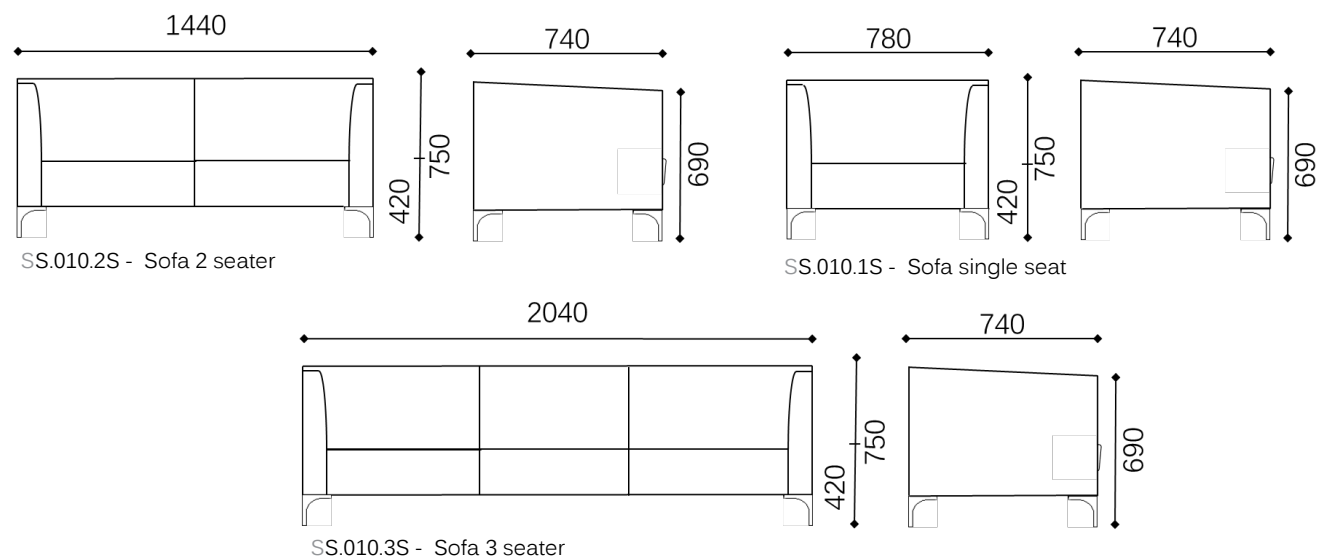



## BASE

Tubular aluminium frame and cast aluminium round legs polished chromed or powder coated finished.

## UPHOLSTERY

SS012 can be upholstered in a wide range of contract fabrics, eco-leathers and genuine leathers from Spaceform's standard upholstery collection. Customer's Own material – fabrics and leathers – are applicable subject to Spaceform's approval after testing the submitted samples.

## BASAMENTO

Base tubolare di alluminio con piedini in fusione di alluminio con finitura lucida o verniciata a polveri epossidiche.

## RIVESTIMENTI

SS012 può essere rivestito in un'ampia gamma di tessuti contract, in eco-pelli e pelli naturali della collezione di rivestimenti Spaceform. L'uso di materiali cliente – tessuti o pelli – è consentito previo approvazione di Spaceform dopo aver testato i relativi campioni.

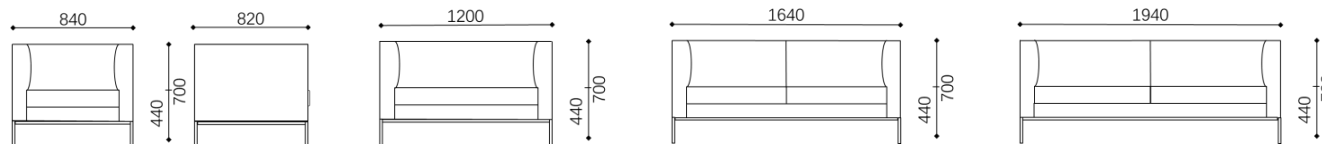

SS.012.1S - Armchair

SS.012.15 - Armchair

SS.012.2S - Sofa 2 seater

SS.012.3S - Sofa 3 seater

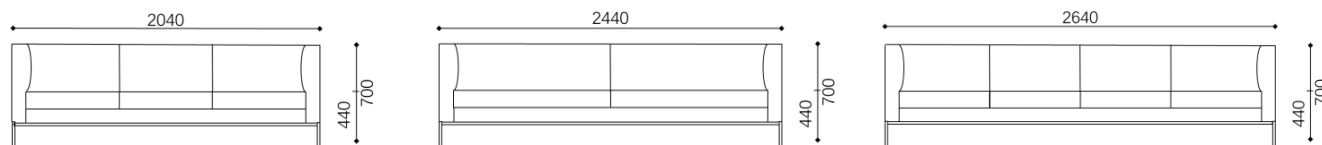

SS.012.3S3 - Sofa 3 seater large,  
3 cushions

SS.01.4S - Sof2a 4 seater

SS.012.4S4 - Sofa 4 seater large,  
4 cushions



## BASE

Cylindrical Steel legs finished with epoxy powder coating or chromed.

## UPHOLSTERY

SS016 can be upholstered in a wide range of contract fabrics, eco-leathers and genuine leathers from Spaceform's standard upholstery collection. Customer's Own material – fabrics and leathers – are applicable subject to Spaceform's approval after testing the submitted samples.

## BASAMENTO

*Gambe cilindriche verniciate a polveri epossidiche oppure cromate.*

## RIVESTIMENTI

*SS016 può essere rivestito in un'ampia gamma di tessuti contract, in eco-pelli e pelli naturali della collezione di rivestimenti Spaceform. L'uso di materiali cliente – tessuti o pelli – è consentito previo approvazione di Spaceform dopo aver testato i relativi campioni.*

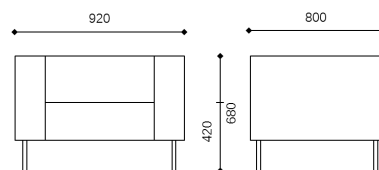

SS.016.1S - Armchair

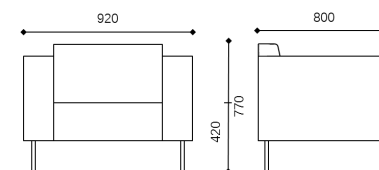

SS.016.1A - Armchair high back

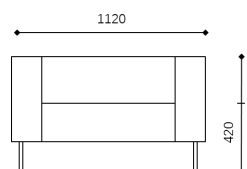

SS.016.1S2 - Large armchair

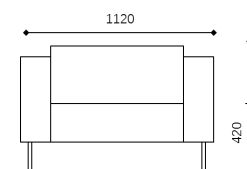

SS.016.1A2 - Large armchair high back

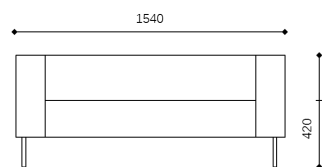

SS.016.2S - 2 seater sofa

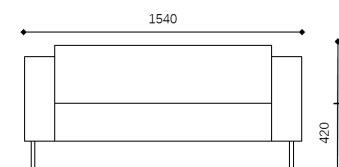

SS.016.2A - 2 seater sofa high back

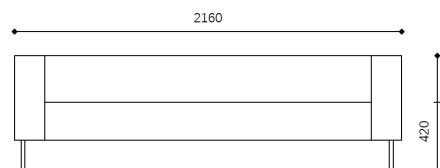

SS.016.3S - 3 seater sofa

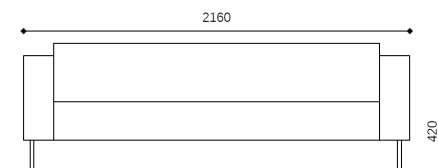

SS.016.3A - 3 seater high back

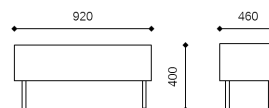

SS.016.P9  
Ottoman

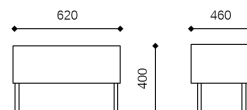

SS.016.P6  
Ottoman

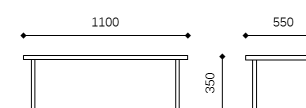

SS.016.TR  
rectangular table

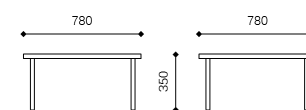

SS.016.TQ  
square table



## BASE

Square tubular Steel frame finished with epoxy powder coating or chromed.

## UPHOLSTERY

SS022 can be upholstered in a wide range of contract fabrics, eco-leathers and genuine leathers from Spaceform's standard upholstery collection. Customer's Own material – fabrics and leathers – are applicable subject to Spaceform's approval after testing the submitted samples.

## BASAMENTO

Base in tubo metallo sezione quadrata, verniciata a polveri epossidiche o cromato.

## RIVESTIMENTI

SS022 può essere rivestito in un'ampia gamma di tessuti contract, in eco-pelli e pelli naturali della collezione di rivestimenti Spaceform. L'uso di materiali cliente – tessuti o pelli – è consentito previo approvazione di Spaceform dopo aver testato i relativi campioni.

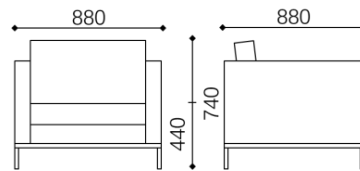

SS.022.1S - Sofa single seat

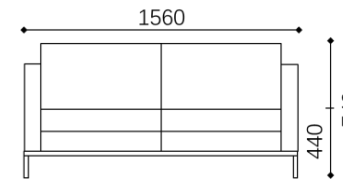

SS.022.2S - Sofa 2 seater

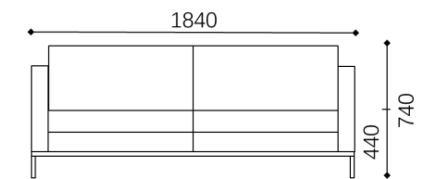

SS.022.2S2 - Sofa 3 seater

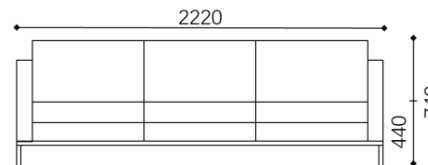

SS.022.3S - Sofa 3 seater large

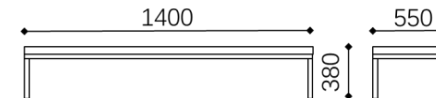

SS.022.TR - Low table

## BASE

Inner wooden frame.

## UPHOLSTERY

8CUBE can be upholstered in a wide range of contract fabrics, eco-leathers and genuine leathers from Spaceform's standard upholstery collection. Customer's Own material – fabrics and leathers – are applicable subject to Spaceform's approval after testing the submitted samples.

## BASAMENTO

Struttura interna in legno con pannellature laterali.

## RIVESTIMENTI

8CUBE può essere rivestito in un'ampia gamma di tessuti contract, in eco-pelli e pelli naturali della collezione di rivestimenti Spaceform.

L'uso di materiali cliente – tessuti o pelli – è consentito previo approvazione di Spaceform dopo aver testato i relativi campioni.

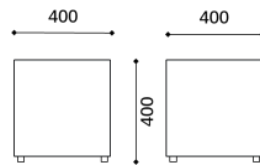

SS.8C.1 - Ottoman 40x40cm

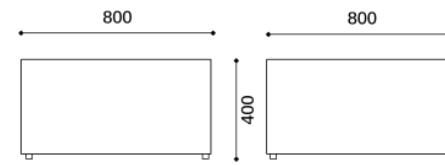

SS.8C.2 - Ottoman 80x80cm

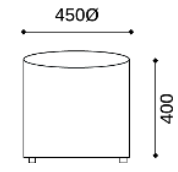

SS.8C.1R - Round Ottoman Ø45cm

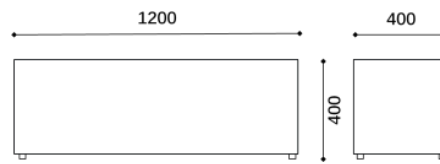

SS.8C.3 - Bench 120x40cm

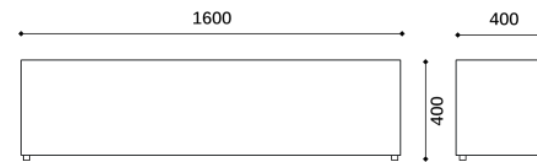

SS.8C.4 - Bench 160x40cm

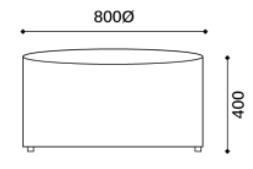

SS.8C.2R - Round Ottoman Ø80cm



# SS031, SS032, SS036 BREAKOUT&CHAIR

## BASES

All types of bases are Chromed as standard. For min. quantities of 30 units, bases can be painted Black RAL 9005. Other colors to be verified upon request.

## UPHOLSTERY

SS031 – SS032 – SS036 can be upholstered in a wide range of contract fabrics, eco-leathers and genuine leathers from Spaceform's standard upholstery collection. Customer's Own material – fabrics and leathers – are applicable subject to Spaceform's approval after testing the submitted samples.

## BASAMENTI

Tutti i tipi di basi sono con finitura cromata standard. Per quantità minime di 30 unità, i basamenti possono essere verniciati in colore nero RAL 9005. Altri colori da verificarsi secondo richiesta.

## RIVESTIMENTI

SS031 – SS032 – SS036 possono essere rivestite in un'ampia gamma di tessuti contract, in eco-pelli e pelli naturali della collezione di rivestimenti Spaceform. L'uso di materiali cliente – tessuti o pelli – è consentito previo approvazione di Spaceform dopo aver testato i relativi campioni.

## SS036



## SS031

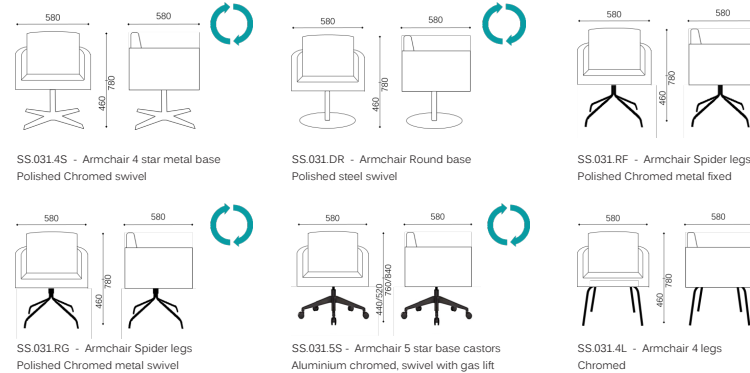

## SS032

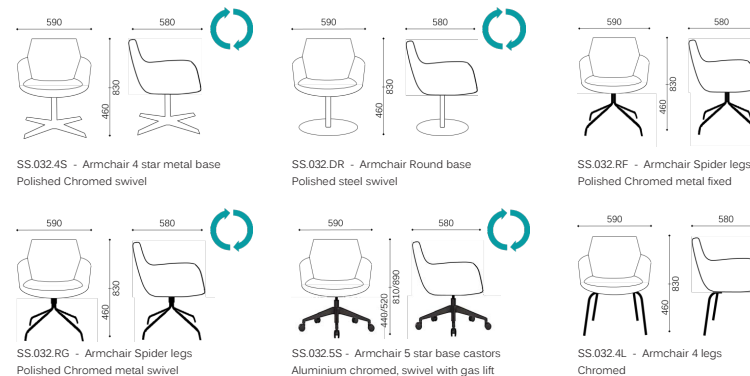



## BASES

All types of bases are Chromed as standard. For min. quantities of 30 units, bases can be painted Black RAL 9005. Other colors to be verified upon request.

## UPHOLSTERY

SS033 can be upholstered in a wide range of contract fabrics, eco-leathers and genuine leathers from Spaceform's standard upholstery collection. Customer's Own material – fabrics and leathers – are applicable subject to Spaceform's approval after testing the submitted samples.

## BASAMENTI

Tutti i tipi di basi sono con finitura cromata standard. Per quantità minime di 30 unità, i basamenti possono essere verniciati in colore nero RAL 9005. Altri colori da verificarsi secondo richiesta.

## RIVESTIMENTI

SS033 può essere rivestita in un'ampia gamma di tessuti contract, in eco-pelli e pelli naturali della collezione di rivestimenti Spaceform. L'uso di materiali cliente – tessuti o pelli – è consentito previo approvazione di Spaceform dopo aver testato i relativi campioni.

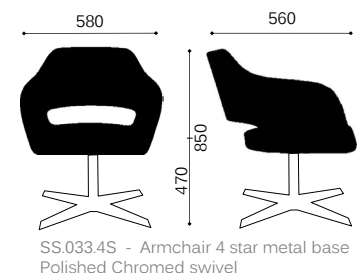
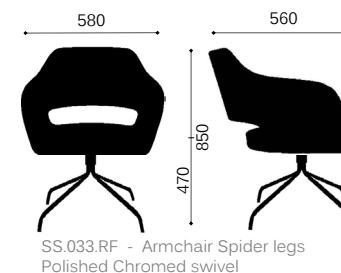
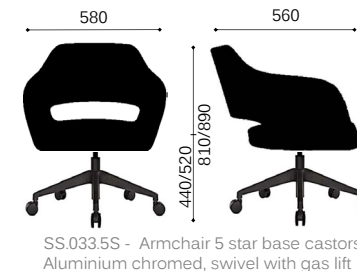
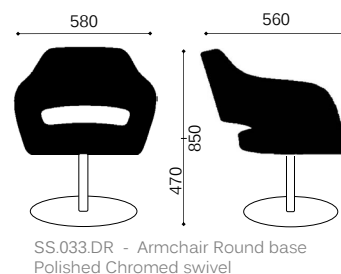
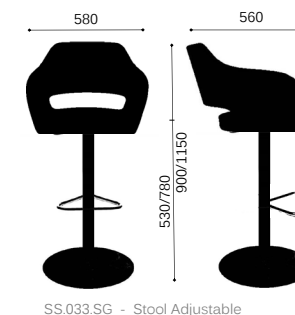
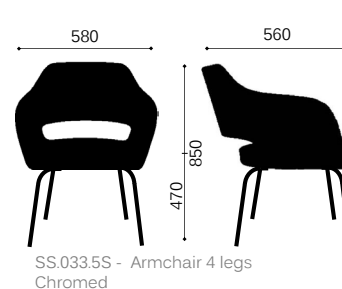





## SS034 BREAKOUT&CHAIR

### BASE

Four rounded ash wood legs, available in several finishes.

### UPHOLSTERY

SS034\_1 can be upholstered in a wide range of contract fabrics, eco-leathers and genuine leathers from Spaceform's standard upholstery collection. Customer's Own material – fabrics and leathers – are applicable subject to Spaceform's approval after testing the submitted samples.

### BASAMENTO

Struttura a quattro gambe tonde in legno di frassino disponibile in svariate finiture.

### RIVESTIMENTI

SS034\_1 può essere rivestita in un'ampia gamma di tessuti contract, in eco-pelli e pelli naturali della collezione di rivestimenti Spaceform. L'uso di materiali cliente – tessuti o pelli – è consentito previo approvazione di Spaceform dopo aver testato i relativi campioni.

### BASE

Four beech wood legs, available in several finishes or Metal legs chromed finished.

### UPHOLSTERY

SS034\_2 can be upholstered in a wide range of contract fabrics, eco-leathers and genuine leathers from Spaceform's standard upholstery collection. Customer's Own material – fabrics and leathers – are applicable subject to Spaceform's approval after testing the submitted samples.

### BASAMENTO

Struttura a quattro gambe in legno di faggio disponibile in svariate finiture o in metallo cromato.

### RIVESTIMENTI

SS034\_2 può essere rivestita in un'ampia gamma di tessuti contract, in eco-pelli e pelli naturali della collezione di rivestimenti Spaceform. L'uso di materiali cliente – tessuti o pelli – è consentito previo approvazione di Spaceform dopo aver testato i relativi campioni.

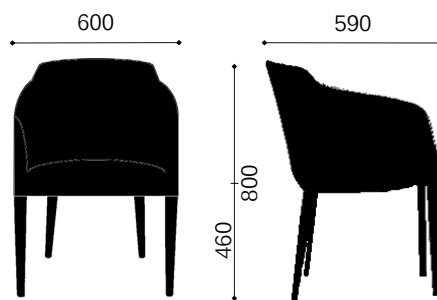

SS.034.1.4 - Armchair 4 legs  
Ash wood stained at color.

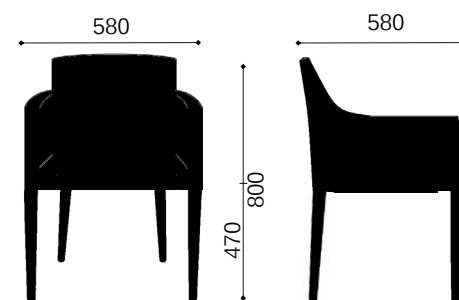

SS.034.2.4 - Armchair 4 legs  
Beech wood stained at color.



## BASES

All types of bases are Chromed as standard. For min. quantities of 30 units, bases can be painted Black RAL 9005. Other colors to be verified upon request.

## UPHOLSTERY

SS035 can be upholstered in a wide range of contract fabrics, eco-leathers and genuine leathers from Spaceform's standard upholstery collection. Customer's Own material – fabrics and leathers – are applicable subject to Spaceform's approval after testing the submitted samples.

## BASAMENTI

Tutti i tipi di basi sono con finitura cromata standard. Per quantità minime di 30 unità, i basamenti possono essere verniciati in colore nero RAL 9005. Altri colori da verificarsi secondo richiesta.

## RIVESTIMENTI

SS035 può essere rivestita in un'ampia gamma di tessuti contract, in eco-pelli e pelli naturali della collezione di rivestimenti Spaceform. L'uso di materiali cliente – tessuti o pelli – è consentito previo approvazione di Spaceform dopo aver testato i relativi campioni.

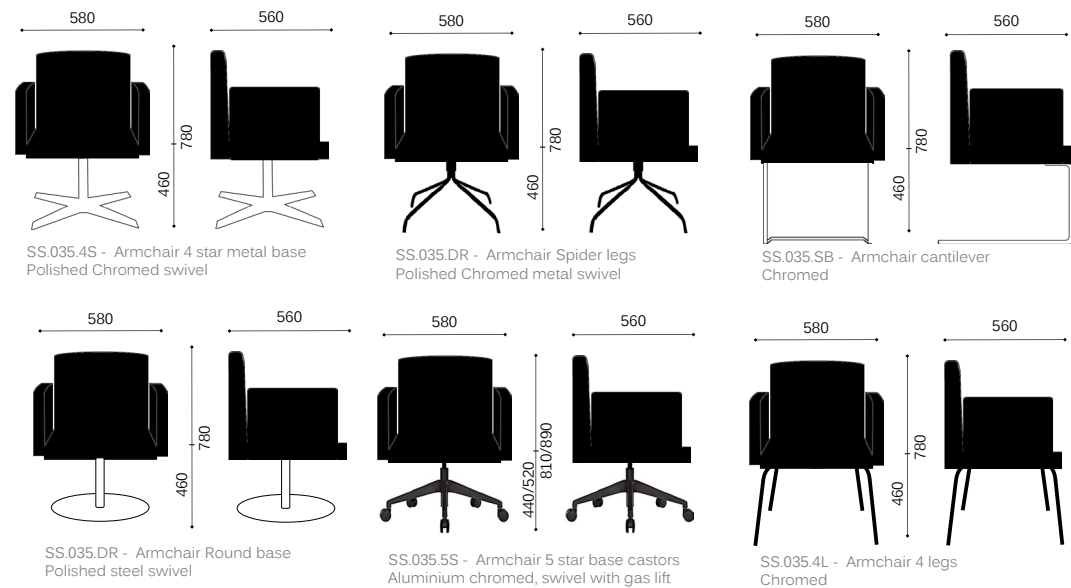



## BASES

All types of bases are Chromed as standard. For min. quantities of 30 units, bases can be painted Black RAL 9005. Other colors to be verified upon request.

## UPHOLSTERY

SS037 can be upholstered in a wide range of contract fabrics, eco-leathers and genuine leathers from Spaceform's standard upholstery collection. Customer's Own material – fabrics and leathers – are applicable subject to Spaceform's approval after testing the submitted samples.

## BASAMENTI

Tutti i tipi di basi sono con finitura cromata standard. Per quantità minime di 30 unità, i basamenti possono essere verniciati in colore nero RAL 9005. Altri colori da verificarsi secondo richiesta.

## RIVESTIMENTI

SS037 può essere rivestita in un'ampia gamma di tessuti contract, in eco-pelli e pelli naturali della collezione di rivestimenti Spaceform. L'uso di materiali cliente – tessuti o pelli – è consentito previo approvazione di Spaceform dopo aver testato i relativi campioni.

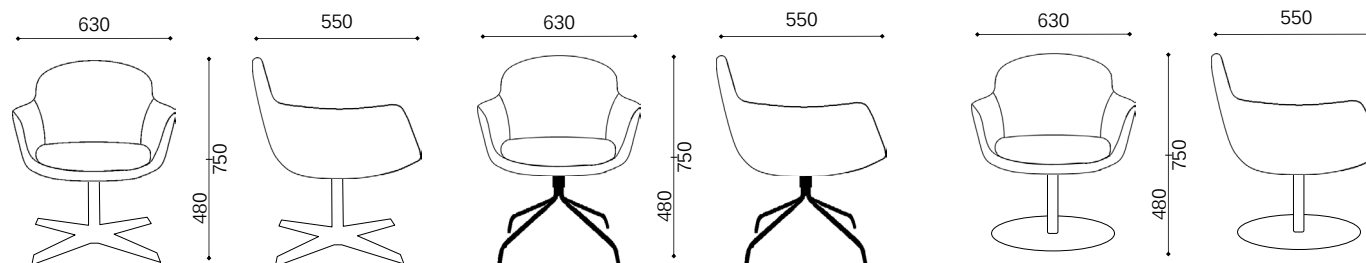

SS.037.4S - Armchair 4 star metal  
Polished Chromed swivel

SS.037.RG - Armchair Spider legs  
Polished Chromed metal swivel

SS.037.DR - Armchair Round base  
Polished steel swivel

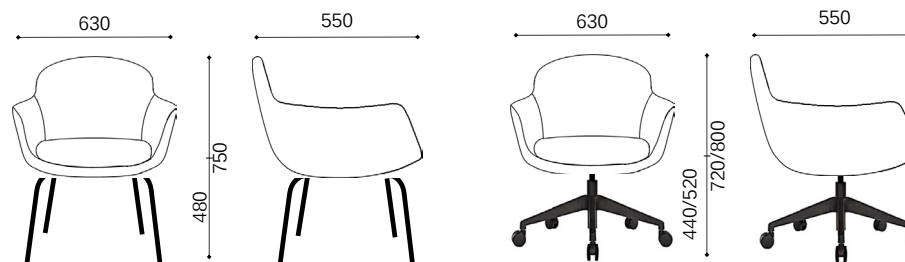

SS.037.4L - Armchair 4 legs  
Chromed

SS.037.5S - Armchair 5 star base castors  
Aluminium chromed, swivel with gas lift



## BASE

Floor protective fixed black anti-skid glides or Castors.

## UPHOLSTERY

SS038 can be upholstered in a wide range of contract fabrics, eco-leathers and genuine leathers from Spaceform's standard upholstery collection. Customer's Own material – fabrics and leathers – are applicable subject to Spaceform's approval after testing the submitted samples.

## BASE

*Piedini anti scivolo fissi oppure ruote.*

## RIVESTIMENTI

*SS038 possono essere rivestiti in un'ampia gamma di tessuti contract, in eco-pelli e pelli naturali della collezione di rivestimenti Spaceform. L'uso di materiali cliente – tessuti o pelli – è consentito previo approvazione di Spaceform dopo aver testato i relativi campioni.*

### SS038\_1

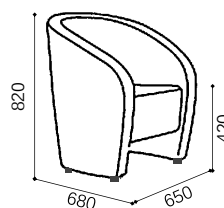

SS.038.1.P - Armchair with glides

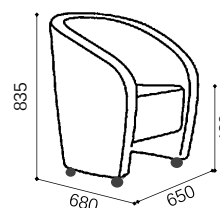

SS.038.1.R - Armchair with castors

### SS038\_2

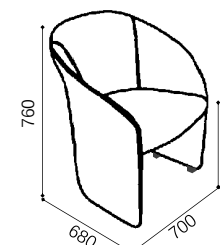

SS.038.2.P - Armchair with glides

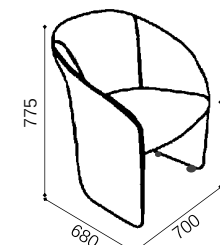

SS.038.2.R - Armchair with castors

### SS038\_3

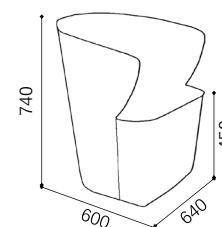

SS.038.3.P - Armchair with glides

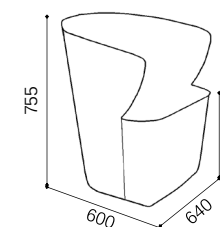

SS.038.3.R - Armchair with castors



## BASE

Floor protective fixed black anti-skid glides or Castors.

## UPHOLSTERY

SS038 can be upholstered in a wide range of contract fabrics, eco-leathers and genuine leathers from Spaceform's standard upholstery collection. Customer's Own material – fabrics and leathers – are applicable subject to Spaceform's approval after testing the submitted samples.

## BASE

*Piedini anti scivolo fissi oppure ruote.*

## RIVESTIMENTI

*SS038 possono essere rivestiti in un'ampia gamma di tessuti contract, in eco-pelli e pelli naturali della collezione di rivestimenti Spaceform. L'uso di materiali cliente – tessuti o pelli – è consentito previo approvazione di Spaceform dopo aver testato i relativi campioni.*





## BASES

All types of bases are Chromed as standard. For min. quantities of 30 units, bases can be painted Black RAL 9005. Other colors to be verified upon request.

## UPHOLSTERY

SS042 can be upholstered in a wide range of contract fabrics, eco-leathers and genuine leathers from Spaceform's standard upholstery collection. Customer's Own material – fabrics and leathers – are applicable subject to Spaceform's approval after testing the submitted samples.

## BASAMENTI

Tutti i tipi di basi sono con finitura cromata standard. Per quantità minime di 30 unità, i basamenti possono essere verniciati in colore nero RAL 9005. Altri colori da verificarsi secondo richiesta.

## RIVESTIMENTI

SS042 possono essere rivestite in un'ampia gamma di tessuti contract, in eco-pelli e pelli naturali della collezione di rivestimenti Spaceform. L'uso di materiali cliente – tessuti o pelli – è consentito previo approvazione di Spaceform dopo aver testato i relativi campioni.

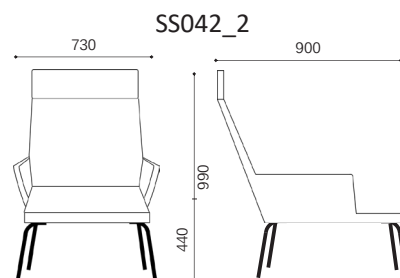

SS.042.2.4L - Armchair 4 legs  
Chromed

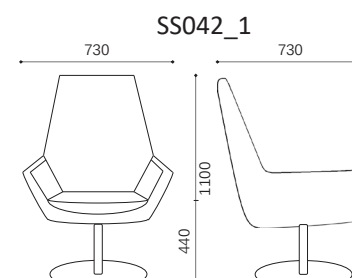

SS.042.1.DR - Armchair Round base  
Polished steel swivel

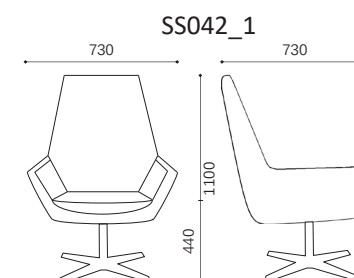

SS.042.1.4S - Armchair 4 star metal  
Polished Chromed swivel

## SS042\_3

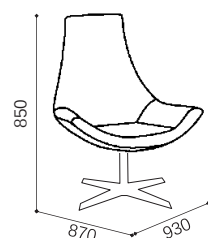

SS.042.3.4S - High chair 4 star metal  
Polished Chromed swivel

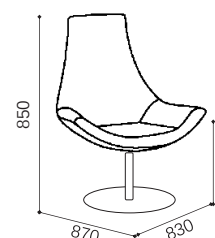

SS.042.3.DR - High chair Round base  
Polished steel swivel

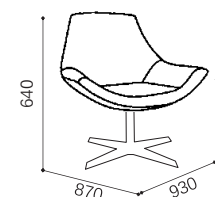

SS.042.3B.4S - Low chair 4 star metal  
Polished Chromed swivel

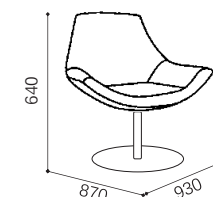

SS.042.3B.DR - Low chair Round base  
Polished steel swivel

## SS042\_3



## BASE

Five star base in die-cast Polished Aluminium or Black Nylon.

## CHASSIS

Framework in die-cast aluminum polished finished.

## MECHANISM

Counterbalanced lockable synchronized mechanism.

## BACKREST

Mesh type with snap lock Lumbar support mechanism. Mesh available in several colors.

## SEAT

Mesh type with front pad absorber. Equipped with depth adjustment.

## ARMRESTS

3D adjustable with soft injected pad.

## UPHOLSTERY

Fully Breathable Elastic Mesh

## BASE

Base in alluminio lucido pressofuso a cinque razze su ruote oppure in Nylon nera.

## STRUTTURA

Telaio in alluminio pressofuso finitura lucida.

## MECCANISMO

Meccanismo sincronizzato controbilanciato bloccabile.

## SCHIENALE

A rete con meccanismo con supporto lombare a scatto. Rete disponibile in diversi colori.

## SEDUTA

A rete con imbottitura assorbente frontale. Fornita di regolatore profondità.

## BRACCIOLI

Regolabili in 3D con imbottitura di appoggio soft stampata.

## RIVESTIMENTO

Rete elastica totalmente traspirante.

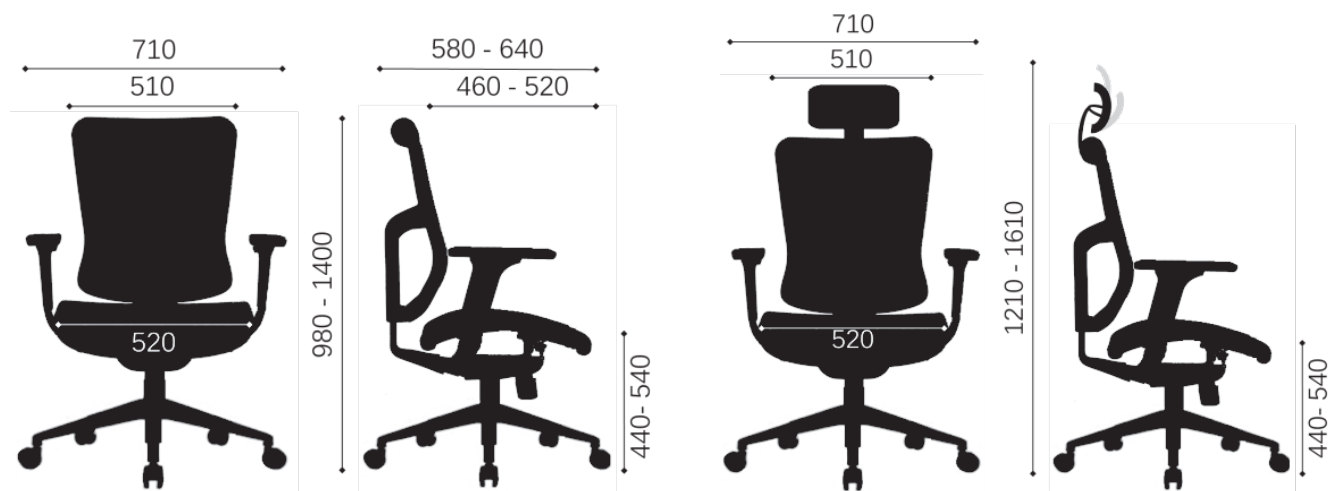

SS.PAK.A – Mid back armchair

SS.PAK.HA – Armchair with Headrest



## BASE

Five star base in die-cast Polished Aluminium or Black Nylon.

## CHASSIS

Framework in die-cast aluminum polished finished or injected Black Nylon.

## MECHANISM

Bodyweight counterbalancing lockable synchronized mechanism.

## BACKREST

Mesh type ergonomically shaped. Mesh available in several colors.

## SEAT

Padded and upholstered type. Equipped with depth adjustment.

## ARMRESTS

3D adjustable with soft injected pad.

## UPHOLSTERY

Fully Breathable Elastic Mesh for backrest. Fabric for seat.

## BASE

Base in alluminio lucido pressofuso a cinque razze su ruote oppure in Nylon nera.

## STRUTTURA

Telaio in alluminio pressofuso finitura lucida oppure in Nylon nero a iniezione.

## MECCANISMO

Meccanismo sincronizzato controbilanciato bloccabile.

## SCHIENALE

A rete ergonomicamente disegnato. Rete disponibile in diversi colori.

## SEDUTA

Imbottita e rivestita. Fornita di regolatore profondità.

## BRACCIOLI

Regolabili in 3D con imbottitura di appoggio soft stampata.

## RIVESTIMENTO

Rete elastica totalmente traspirante per lo schienale. Tessuto per il sedile.

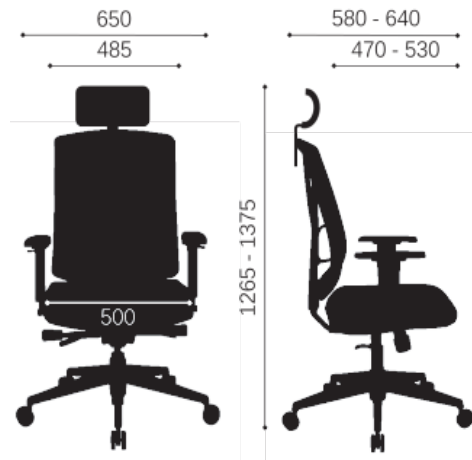

SS.MI3.HP – Armchair

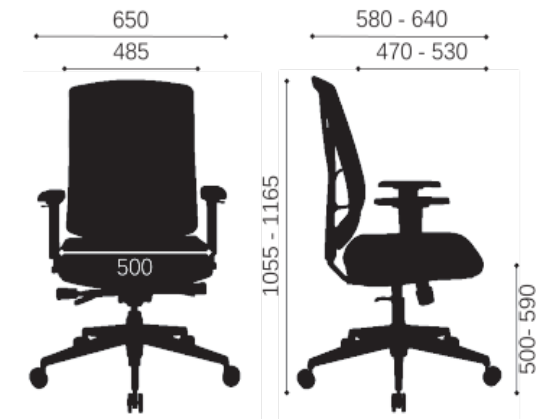

SS.MI3.AP – Armless chair





# MIR3 CHAIR OFFICE

## BASE

Five star base in die-cast Polished Aluminium or Black Nylon.

## CHASSIS

Framework in stainless steel black coated.

## MECHANISM

Synchro-tilt lockable mechanism or Tilt with front lock.

## BACKREST

Mesh type with integrated adjustable lumbar support. Mesh available in several colors.

## SEAT

Padded and upholstered type. Optional depth adjustment.

## ARMRESTS

3D or 2D adjustable or Fixed. Steel chromed support.

## UPHOLSTERY

Fully Breathable Elastic Mesh for backrest. Fabric for seat.

## BASE

Base in alluminio lucido pressofuso a cinque razze su ruote oppure in Nylon nera.

## STRUTTURA

Telaio in acciaio verniciato nero.

## MECCANISMO

Meccanismo sincronizzato bloccabile oppure Basculante con posizione frontale di fermo.

## SCHIENALE

A rete con supporto lombare regolabile integrato. Rete disponibile in diversi colori.

## SEDUTA

Imbottita e rivestita. Fornita di regolatore profondità.

## BRACCIOLI

Regolabili in 3D o 2D oppure Fissi. Supporto braccioli in acciaio cromato.

## RIVESTIMENTO

Rete elastica totalmente traspirante per lo schienale. Tessuto per il sedile.

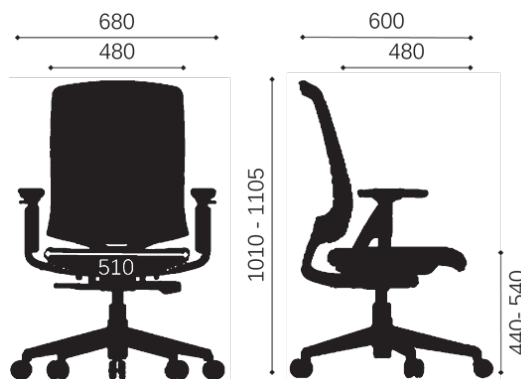

SS.MIR.AP – Armchair

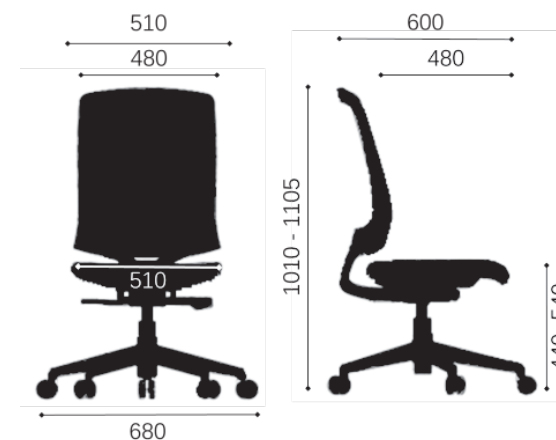

SS.MIR.SB – Armless chair



## Sspace S.r.l

Via Mottarone 36D  
21100 Varese  
Italy

Tel +39 0332 1646541  
Fax +39 0332 1641342  
[info@spaceform.it](mailto:info@spaceform.it)  
[www.spaceform.it](http://www.spaceform.it)

